



**QUAID-E-AZAM SOLAR POWER (PVT.) LTD. (QASPL)
ENERGY DEPARTMENT, GOVERNMENT OF THE
PUNJAB**

BIDDING DOCUMENT

SELECTION OF CONTRACTOR

FOR

**CONSTRUCTION OF ONE (01) ROOM AROUND INVERTER
AND BOX TRANSFORMER AT 100MW POWER PLANT OF
QASPL IN BAHAWALPUR**

**SINGLE STAGE TWO ENVELOPE
(SSTE)**

March 2024

**QUAID-E-AZAM SOLAR POWER (PVT.) LTD. (QASPL)
ENERGY DEPARTMENT, GOVERNMENT OF THE PUNJAB
Address: 03rd Floor, 83-A/E-1, Main Boulevard, Gulberg III, Lahore**



Table of Contents

INVITATION FOR BIDS	5
A. GENERAL.....	8
IB.1. Scope of Bid & Source of Funds.....	8
1.1. Scope of Bid.....	8
1.2. Source of Funds	8
IB.2. Eligible Bidders.....	8
IB.3. Cost of Bidding	8
B. BIDDING DOCUMENTS	8
IB.4. Contents of Bidding Documents	8
IB.5. Clarification of Bidding Documents	9
IB.6. Amendment of Bidding Documents.....	9
C. PREPARATION OF BIDS.....	9
IB.7. Language of Bid.....	9
IB.8. Documents Comprising the Bid.....	10
IB.9. Sufficiency of Bid	10
IB.10. Bid Prices, Currency of Bid and Payment.....	10
IB.11. Documents Establishing Bidder’s Eligibility and Qualifications	11
IB.12. Documents Establishing Works’ Conformity to Bidding Documents	11
IB.13. IB.13 Bid Security.....	11
IB.14. Validity of Bids, Format, Signing, and Submission of Bid.....	12
D. SUBMISSION OF BID	12
IB.15. Deadline for Submission, Modification & Withdrawal of Bids.....	12
E. BID OPENING AND EVALUATION	13
IB.16. Bid Opening, Clarification, and Evaluation.....	13
16.8. Evaluated Bid Price.....	14
16.9. Evaluation Methods	14
IB.17. Confidentiality	15
F. AWARD OF CONTRACT.....	15
IB.18. Post Qualification.....	15
IB.19. Award Criteria & Employer’s Right	15
IB.20. Notification of Award & Signing of Contract Agreement	16
IB.21. Performance Security	16
G. BIDDING DATA	17
FORM OF BID AND SCHEDULES TO BID	19
FORM OF BID for Technical Proposal.....	20
SCHEDULE – A TO BID (SCHEDULE OF PRICES).....	24
Bill of Quantities.....	25
SCHEDULE - B TO BID (SPECIFIC WORKS DATA).....	27
SCHEDULE – C TO BID (WORKS TO BE PERFORMED BY SUBCONTRACTORS)	29



CONDITIONS OF CONTRACT & CONTRACT DATA	33
1. GENERAL PROVISIONS	35
1.1 Definitions.....	35
1.2 Interpretation.....	36
1.3 Priority of Documents.....	36
1.4 Law	36
1.5 Communications	37
1.6 Statutory Obligations	37
2. THE EMPLOYER	37
2.1 Provision of Site.....	37
2.2 Permits etc.....	37
2.3 Engineer’s/Employer’s Instructions.....	37
2.4 Approvals.....	37
3. ENGINEER’S/EMPLOYER’S REPRESENTATIVES	37
3.1 Authorized Person.....	37
3.2 Engineer’s/Employer’s Representative.....	37
4. THE CONTRACTOR.....	38
4.1 General Obligations	38
4.2 Contractor’s Representative.....	38
4.3 Subcontracting	38
4.4 Performance Security	38
5. DESIGN BY CONTRACTOR	38
5.1 Contractor’s Design	38
5.2 Responsibility for Design.....	38
6. EMPLOYER’S RISKS	39
6.1 The Employer’s Risks.....	39
7. TIME FOR COMPLETION	39
7.1 Execution of the Works.....	39
7.2 Programme.....	39
7.3 Extension of Time	40
7.4 Late Completion.....	40
8. TAKING-OVER	40
8.1 Completion.....	40
8.2 Taking-Over Notice	40
9. REMEDYING DEFECTS	40
9.1 Remediating Defects.....	40
9.2 Uncovering and Testing	41
10. VARIATIONS AND CLAIMS.....	41



10.1	Right to Vary	
10.2	Valuation of Variations.....	
10.3	Early Warning	41
10.4	Valuation of Claims	42
10.5	Variation and Claim Procedure.....	42
11.	CONTRACT PRICE AND PAYMENT.....	42
11.1	Terms of Payments and Valuation of Work.....	42
11.2	Monthly Statements	42
11.3	Interim Payments	42
11.4	Retention	43
11.5	Final Payment	43
11.6	Currency.....	43
12.	DEFAULT	43
12.1	Default by Contractor.....	43
12.2	Default by Employer.....	43
12.3	Insolvency	44
12.4	Payment upon Termination.....	44
13.	RISKS AND RESPONSIBILITIES.....	44
13.1	Contractor’s Care of the Works	44
13.2	Force Majeure	45
14.	INSURANCE.....	45
14.1	Arrangements	45
14.2	Default.....	45
15.	RESOLUTION OF DISPUTES.....	45
15.1	Engineer’s Decision	45
15.2	Notice of Dissatisfaction.....	46
15.3	Arbitration.....	46
16.	INTEGRITY PACT	46
17.	Liquidated Damages for Delay	47
	CONTRACT DATA.....	48
	Conditions of Contract	48
	STANDARD FORMS.....	51
	FORM OF PERFORMANCE SECURITY (Bank Guarantee).....	52
	FORM OF CONTRACT AGREEMENT	53
	Affidavit for Non-Blacklisting of Firm.....	55
	TECHNICAL SPECIFICATIONS.....	57



Quaid-e-Azam Solar Power (Pvt) Ltd

INVITATION FOR BIDS



Lahore, March 2024

**Subject: INVITATION OF BIDS FOR CONSTRUCTION OF ONE (01) ROOM
AROUND INVERTER AND BOX TRANSFORMER AT 100MW
POWER PLANT OF QASPL IN BAHAWALPUR**

1. The **Quaid-e-Azam Solar Power (Pvt.) Ltd. (QASPL), Energy Department, Government of the Punjab** (hereinafter called "Procuring Entity") now invites proposals to provide the following contracting services for **DESIGN, SUPPLY, CONSTRUCTION OF ONE (01) ROOM AROUND INVERTER AND BOX TRANSFORMER AT 100MW POWER PLANT OF QASPL IN BAHAWALPUR**
2. A firm will be selected, under **Single Stage-Two Envelopes (SSTE) Bidding** and procedures described in this Bidding Document, in accordance with the PEC / PPR Rules 2014 (Latest).
3. The Bidding Document includes:
 - i. INVITATION FOR BIDS
 - ii. INSTRUCTIONS TO BIDDERS
 - iii. FORM OF BID & SCHEDULES TO BID
 - iv. SCHEDULE OF PRICES
 - v. CONDITIONS OF CONTRACT
 - vi. STANDARD FORMS
 - vii. ANNEX A: TECHNICAL SPECIFICATION

4. Please inform us in writing at the following address:

QASPL Office: 03rd Floor, 83-A/E-1, Main Boulevard, Gulberg III, Lahore, upon receipt that you have received the Letter of Invitation.

5. A complete set of Bidding Documents may be purchased by an interested bidder on submission of a written application to the above office and upon payment of a non-refundable fee of PKR 5000/-.

Initial detail of the project is as follows:



Sr. No.	City	Estimated Cost (Million)	Bid Security (Million)
1	Bahawalpur	13.7	0.6

The Bidders are required to submit the Technical and Financial Bid separately. The Bid Security shall be enclosed in the Technical Bid.

- All bids must be accompanied by a Bid Security in the amount stated above in the shape of CDR/Bank Guarantee in the Name of **“Quaid-e-Azam Solar Power (Pvt.) Ltd.”** and must be delivered at ***QASPL Office:*** 3rd Floor 83-A/E-1, Main Boulevard, Ghalib Road, Gulberg III, Lahore on or before ***22nd March, 2024 in sealed envelopes at 02:00 pm.*** Technical Bids will be opened at ***02:30 pm*** on the same day in the presence of bidders' representatives who choose to attend at the same address.

General Manager Technical
Quaid-e-Azam Solar Power (Pvt.) Ltd.
Energy Department, Lahore.



Quaid-e-Azam Solar Power (Pvt) Ltd

INSTRUCTIONS TO BIDDERS

INSTRUCTIONS TO BIDDERS

A. GENERAL

IB.1. Scope of Bid & Source of Funds

1.1. Scope of Bid

The Employer as defined in the Bidding Data (hereinafter called “the Employer”) wishes to receive Bids for the Works summarized in the Bidding Data (hereinafter referred to as “the Works”).

Bidders must quote for the complete scope of work. Any Bid covering the partial scope of work will be rejected as non-responsive.

1.2. Source of Funds

The Employer has arranged funds from its own sources. [or any other source which may be indicated accordingly]

IB.2. Eligible Bidders

2.1. Bidding is open to all firms and persons meeting the following requirements:

- a) The Bidder must be registered with PEC in category C-5 or above with codes of CE-10
- b) The Bidder must be registered FPR, Punjab Revenue Authority for Sales Tax and Income Tax and must be active taxpayer Copies of registration certificates to be attached.
- c) The bidding firm/company must be registered with SECP/Registrar of Firm. Copy of registration certificate(s) to be provided
- d) Bidder must have prior experience of similar work.
- e) Bidder must not be blacklisted by any government office or autonomous body

IB.3. Cost of Bidding

The bidder shall bear all costs associated with the preparation and submission of its bid and the Employer will in no case be responsible or liable for those costs, regardless of the conduct or outcome of the bidding process.

B. BIDDING DOCUMENTS

IB.4. Contents of Bidding Documents

4.1. In addition to Invitation for Bids, the Bidding Documents are those stated below and should be read in conjunction with any Addendum issued in accordance with Sub- Clause IB.6.1.

1. Instructions to Bidders & Bidding Data
2. Schedules to Bid comprising the following:
 - (i) **Schedule A:** Schedule of Prices (BOQ)
 - (ii) **Schedule B:** Specific Works Data



(iii) **Schedule C:** Works to be Performed by Subcontractors

- (iv) **Schedule D:** Proposed Programme of Works
- (v) **Schedule E:** Method of Performing Works

- 3. Conditions of Contract & Contract Data
- 4. Standard Forms:
 - (i) Form of Performance Security
 - (ii) Form of Contract Agreement
 - (iii) Affidavit of Non-Blacklisting of the firm
- 5. Specifications
- 6. Drawings, if any

IB.5. Clarification of Bidding Documents

- 5.1. A prospective bidder requiring any clarification(s) in respect of the Bidding Documents may notify the Engineer/Employer at the Employer's/Engineer's address indicated in the Bidding Data.
- 5.2. The Engineer/Employer will respond to any request for clarification that it receives earlier than seven (07) days prior to the deadline for the submission of Bids. Copies of the Engineer/Employer's response will be forwarded to all prospective bidders, at least three (3) days prior to the deadline for submission of Bids, who have received the Bidding Documents including a description of the inquiry but without identifying its source.

IB.6. Amendment of Bidding Documents

- 6.1. At any time prior to the deadline for submission of Bids, the Employer may, for any reason, whether at his own initiative or in response to a clarification requested by a prospective bidder, modify the Bidding Documents by issuing an addendum.
- 6.2. Any addendum thus issued shall be part of the Bidding Documents pursuant to Sub- Clause 6.1 hereof and shall be communicated in writing to all purchasers of the Bidding Documents. Prospective bidders shall acknowledge receipt of each addendum in writing to the Employer.
- 6.3. To afford prospective bidders reasonable time in which to take an addendum into account in preparing their Bids, the Employer may at its discretion extend the deadline for submission of Bids.

C.

PREPARATION OF BIDS

IB.7. Language of Bid

- 7.1. The bid prepared by the bidder and all correspondence and documents relating to the Bid, exchanged by the bidder and the Employer shall be written in the English language, provided that any printed literature furnished by the bidder may be written in another language so long as accompanied by an English translation of its pertinent passages in which case, for purposes of interpretation of the Bid, the English translation shall govern.



IB.8. Documents Comprising the Bid

- 8.1. The bid prepared by the bidder shall comprise the following components:
- (a) Covering Letter
 - (b) Form of Bid duly filled, signed and sealed, in accordance with Sub-Clause IB.14.3.
 - (c) Schedules (A to F) to Bid duly filled and initialed, in accordance with the instructions contained therein & in accordance with Sub-Clause IB14.3.
 - (d) Schedule of Prices as mentioned in Bidding document to be enclosed in separate sealed Financial Proposal
 - (e) Affidavit of Non-Blacklisting as attached in forms of bids.
 - (f) Bid Security furnished in accordance with Clause IB.13.
 - (g) Power of Attorney in accordance with Sub-Clause IB 14.5.
 - (h) Documentary evidence in accordance with Clause IB.11
 - (i) Documentary evidence in accordance with Clause IB.12.
 - (j) Documents as per Clause IB.2.
 - (k) JV agreement (if applicable)
 - (l) Power of attorney for signing of proposal
 - (m) Power of attorney for lead partner (in case of JV)

IB.9. Sufficiency of Bid

- 9.1. Each bidder shall satisfy himself before Bidding as to the correctness and sufficiency of his Bid and of the rates and prices entered in the Schedule of Prices, which rates and prices shall except in so far as it is otherwise expressly provided in the Contract, cover all his obligations under the Contract and all matters and things necessary for the proper completion of the Works.
- 9.2. The bidder is advised to obtain for himself at his own cost and responsibility all information that may be necessary for preparing the bid and entering into a Contract for the execution of the Works.

IB.10. Bid Prices, Currency of Bid and Payment

- 10.1. The bidder shall fill up the Schedule of Prices (Schedule A to Bid) indicating the unit rates and prices of the Works to be performed under the Contract. Prices in the Schedule of Prices shall be entered keeping in view the instructions contained in the Preamble to Schedule of Prices.



10.2. Unless otherwise stipulated in the Conditions of Contract, prices quoted by the bidder shall remain fixed during the bidder's performance of the Contract and not subject to variation on any account.

10.3. The unit rates and prices in the Schedule of Prices shall be quoted by the bidder in the currency as stipulated in Bidding Data.

IB.11. Documents Establishing Bidder's Eligibility and Qualifications

11.1. Pursuant to Clause IB.8, the bidder shall furnish, as part of its bid, documents establishing the bidder's eligibility to bid and its qualifications to perform the Contract if its bid is accepted.

11.2. Bidder/Manufacturer must possess and provide evidence of its capability and the experience as stipulated in Bidding Data and the Qualification Criteria stipulated in the Bidding Documents.

IB.12. Documents Establishing Works' Conformity to Bidding Documents

12.1. The documentary evidence of the Works' conformity to the Bidding Documents may be in the form of literature, drawings and data and the bidder shall furnish documentation as set out in Bidding Data.

12.2. The bidder shall note that standards for workmanship, material and equipment, and references to brand names or catalogue numbers, if any, designated by the Employer in the Technical Provisions are intended to be descriptive only and not restrictive.

IB.13. IB.13 Bid Security

13.1. Each bidder shall furnish, as part of his bid, at the option of the bidder, a Bid Security in the amount stipulated in Bidding Data in Pak. Rupees in the form of Pay Order /CDR from Scheduled Bank in Pakistan in favor of the Employer valid for a period up to ninety (90) days beyond the bid validity date.

13.2. Any bid not accompanied by an acceptable Bid Security shall be rejected by the Employer as non-responsive.

13.3. The bid securities of unsuccessful bidders will be returned upon award of contract to the successful bidder or on the expiry of validity of Bid Security whichever is earlier.

13.4. The Bid Security of the successful bidder will be returned when the bidder has furnished the required Performance Security, pursuant to Clause IB.21 and signed the Contract Agreement, pursuant to Sub-Clauses IB.20.2 & 20.3.

13.5. The Bid Security may be forfeited:

- (a) if a bidder withdraws his bid during the period of bid validity; or
- (b) if a bidder does not accept the correction of his Bid Price, pursuant to Sub-Clause 16.4 (b) hereof; or
- (c) in the case of a successful bidder, if he fails to:
 - (i) furnish the required Performance Security in accordance with Clause



- IB.21, or
(ii) sign the Contract Agreement, in accordance with Sub-Clauses IB.20.2 & 20.3.

IB.14. Validity of Bids, Format, Signing, and Submission of Bid

- 14.1. Bids shall remain valid for the period stipulated in the Bidding Data after the date of bid opening.
- 14.2. All Schedules to Bid are to be properly completed and signed.
- 14.3. No alteration is to be made in the Form of Bid except in filling up the blanks as directed. If any alteration be made or if these instructions be not fully complied with, the bid may be rejected.
- 14.4. Each bidder shall prepare the Original and a number of copies of Technical and Financial proposal as specified in the Bidding Data of the documents comprising the bid as described in Clause IB.8 and clearly mark them “ORIGINAL” and “COPY” as appropriate. In the event of a discrepancy between them, the original shall prevail.
- 14.5. The original and all copies of the bid shall be typed or written in indelible ink and shall be signed by a person or persons duly authorized to sign (in the case of copies, Photostats are also acceptable). This shall be indicated by submitting a written Power of Attorney authorizing the signatory of the bidder to act for and on behalf of the bidder. All pages of the bid shall be initialed and official seal be affixed by the person or persons signing the bid.
- 14.6. The Bid shall be delivered in person or sent by registered mail at the address to Employer as given in Bidding Data.

D. SUBMISSION OF BID

IB.15. Deadline for Submission, Modification & Withdrawal of Bids

- 15.1. Bids must be received by the Employer at the address/provided in Bidding Data not later than the time and date stipulated therein.
- 15.2. Bids submitted through telegraph, telex, fax or e-mail shall not be considered.
- 15.3. Any bid received by the Employer after the deadline for submission prescribed in Bidding Data will be returned unopened to such bidder.
- 15.4. Any bidder may modify or withdraw his bid after bid submission provided that the modification or written notice of withdrawal is received by the Employer prior to the deadline for submission of bids.
- 15.5. Withdrawal of a bid during the interval between the deadline for submission of bids and the expiration of the period of bid validity specified in the Form of Bid may result in forfeiture of the Bid Security pursuant to Sub-Clause IB.13.5(a).



E. BID

OPENING AND EVALUATION

IB.16. Bid Opening, Clarification, and Evaluation

- 16.1. The Employer will open the bids, in the presence of bidders' representatives who choose to attend, at the time, date, and location stipulated in the Bidding Data.
- 16.2. The bidder's name, Bid Prices, any discount, the presence or absence of Bid Security, and such other details as the Employer at its discretion may consider appropriate, will be announced by the Employer at the bid opening. The Employer will record the minutes of the bid opening. Representatives of the bidders who choose to attend shall sign the attendance sheet.

Any Bid Price or discount which is not read out and recorded at bid opening will not be taken into account in the evaluation of bid.

- 16.3. To assist in the examination, evaluation and comparison of Bids the Engineer/Employer may, at its discretion, ask the bidder for a clarification of its Bid. The request for clarification and the response shall be in writing and no change in the price or substance of the Bid shall be sought, offered or permitted.

16.4.

- a) Prior to the detailed evaluation, pursuant to Sub-Clauses IB.16.7 to 16.9, the Engineer/Employer will determine the substantial responsiveness of each bid to the Bidding Documents. For purpose of these Clauses, a substantially responsive bid is one which conforms to all the terms and conditions of the Bidding Documents without material deviations. It will include to determine the requirements listed in Bidding Data.

- b) Arithmetical errors will be rectified on the following basis:

If there is a discrepancy between the unit price and total price that is obtained by multiplying the unit price and quantity, the unit price shall prevail and the total price shall be corrected. If there is a discrepancy between the words and figures the amount in words shall prevail. If there is a discrepancy between the Total Bid price entered in Form of Bid and the total shown in Schedule of Prices-Summary, the amount stated in the Form of Bid will be corrected by the Employer in accordance with the Corrected Schedule of Prices.

If the bidder does not accept the corrected amount of Bid, his Bid will be rejected and his Bid Security forfeited.

- 16.5. A Bid determined as substantially non-responsive will be rejected and will not subsequently be made responsive by the Bidder by correction of the non-conformity.
- 16.6. Any minor informality or non-conformity or irregularity in a Bid which does not constitute a material deviation may be waived by the Employer, provided such waiver does not prejudice or affect the relative ranking of any other bidders.
- 16.7. The Engineer/Employer will evaluate and compare only the bids previously determined to be substantially responsive pursuant to Sub-Clauses IB.16.4 to 16.6 as per requirements given hereunder. Bids will be evaluated for the complete scope of works. The prices will



be compared on the basis of the Evaluated Bid Price pursuant to Sub-Clause 16.8 hereinbelow.

(a) Technical Evaluation

It will be examined in detail whether the Works offered by the bidder complies with the Technical Provisions of the Bidding Documents. For this purpose, the bidder's data submitted with the bid in Schedule B to Bid will be compared with technical features/criteria of the Works detailed in the Technical Provisions. Other technical information submitted with the bid regarding the Scope of Work will also be reviewed.

(b) Commercial Evaluation

It will be examined in detail whether the bids comply with the commercial/contractual conditions of the Bidding Documents. It is expected that no material deviation/stipulation shall be taken by the bidders.

16.8. Evaluated Bid Price

In evaluating the bids, the Engineer/Employer will determine for each bid in addition to the Bid Price, the following factors (adjustments) in the manner and to the extent indicated below to determine the Evaluated Bid Price:

- (i) Making any correction for arithmetic errors pursuant to Sub-Clause 16.4 hereof.
- (ii) Making an appropriate price adjustment for any other acceptable variation or deviation.
- (iii) Making an appropriate price adjustment for Deviations in terms of Payments (if any and acceptable to the Employer).
- (iv) Discount, if any, offered by the bidders as also read out and recorded at the time of bid opening.

16.9. Evaluation Methods

Pursuant to Sub-Clause 16.8, Para (ii), and (iii) following evaluation methods for price adjustments will be followed:

(i) Price Adjustment for Technical Compliance

The cost of making good any deficiency resulting from technical noncompliance will be added to the Corrected Total Bid Price for comparison purposes only. The adjustments will be applied taking the highest price quoted by other bidders being evaluated in detail in their original Bids for corresponding item. In case of non-availability of price from other bidders, the price will be estimated by the Engineer/Employer.

(ii) Price Adjustment for Commercial Compliance

The cost of making good any deficiency resulting from any quantifiable variations and deviations from the Bid Schedules and Conditions of Contract,



as determined by the Engineer/Employer will be added to the Corrected Total Bid Price for comparison purpose only. Adjustment for commercial compliance will be added to the Corrected Total Bid Prices.

- (iii) Price Adjustment for Deviation in Terms of Payments Refer to Bidding Data

IB.17. Confidentiality

- 17.1. Subject to Sub-Clause IB.16.3 heretofore, no bidder shall contact Engineer/Employer on any matter relating to its Bid from the time of the Bid opening to the time the bid evaluation result is announced by the Employer. The evaluation result shall be announced at least ten (10) days prior to the award of the Contract. The announcement to all bidders will include table(s) comprising readout prices, discounted prices, price adjustments made, final evaluated prices, and recommendations against all the bids evaluated.
- 17.2. Any effort by a bidder to influence an Engineer/Employer in the Bid evaluation, Bid comparison or Contract Award decisions may result in the rejection of his Bid. Whereas, any bidder feeling aggrieved may lodge a written complaint no later than fifteen (15) days after the announcement of the bid evaluation result, however, the mere fact of lodging a complaint shall not warrant suspension of the procurement process.

F. AWARD OF CONTRACT

IB.18. Post Qualification

- 18.1. The Employer, at any stage of the bid evaluation, having credible reasons for or *prima facie* evidence of any defect in supplier's or contractor's capacities, may require the suppliers or contractors to provide information concerning their professional, technical, financial, legal or managerial competence whether already pre-qualified or not:
Provided that such qualification shall only be laid down after recording reasons therefore in writing. They shall form part of the records of that bid evaluation report.
- 18.2. The determination will take into account the bidder's financial and technical capabilities. It will be based upon an examination of the documentary evidence of the bidders' qualifications submitted under Clause IB.11, as well as such other information required in the Bidding Documents.

IB.19. Award Criteria & Employer's Right

- 19.1. Subject to Sub-Clause IB.19.2, the Employer will award the Contract to the bidder whose bid has been determined to be substantially responsive to the Bidding Documents and who has offered the lowest evaluated Bid Price, provided that such bidder has been determined to be qualified to satisfactorily perform the Contract in accordance with the provisions of Clause IB.18.
- 19.2. Notwithstanding Sub-Clause IB.19.1, the Employer reserves the right to annul the bidding process and reject all bids, at any time prior to award of Contract, without thereby incurring any liability to the affected bidders or any obligation to inform the affected bidders of the grounds for the Employer's action except that the grounds for its rejection of all bids shall upon request be communicated, to any bidder who submitted a bid, without justification of



the grounds as per PPRA Punjab Rules 2014 (amended up to date). Notice of the rejection of all the bids shall be given promptly to all the bidders.

IB.20. Notification of Award & Signing of Contract Agreement

- 20.1. Prior to expiration of the period of bid validity prescribed by the Employer, the Employer will notify the successful bidder in writing (“Letter of Acceptance”) that his bid has been accepted.
- 20.2. Within seven (7) days from the date of furnishing of acceptable Performance Security under the Conditions of Contract, the Employer will send the successful bidder the Form of Contract Agreement provided in the Bidding Documents, incorporating all agreements between the parties.
- 20.3. The formal Agreement between the Employer and the successful bidder shall be executed within seven (7) days of the receipt of Form of Contract Agreement by the successful bidder from the Employer.

IB.21. Performance Security

- 21.1. The successful bidder shall furnish to the Employer a Performance Security in the form and the amount and conditions stipulated in Bidding Data within a period of Fourteen (14) days after the receipt of Letter of Acceptance.
- 21.2. Failure of the successful bidder to comply with the requirements of Sub-Clauses IB.20.2 & 20.3 or 21.1 or Clause IB.22 shall constitute sufficient grounds for the annulment of the award and forfeiture of the Bid Security.

**G. BIDDING DATA**

Sr. No.	Data	Description
1.1	Name of Employer	Quaid-e-Azam Solar Power (Pvt) Ltd.
	Brief Description of Works	CONSTRUCTION OF ONE (01) ROOM AROUND INVERTER AND BOX TRANSFORMER AT 100MW POWER PLANT OF QASPL IN BAHAWALPUR Sealed Bids (Single stage two Envelope) are invited for The Construction of Room
1.2	Employer's Address	Quaid-e-Azam Solar Power (Pvt) Ltd. 3 rd Floor 83-A, E/1, Main Boulevard, Gulberg III, Lahore. Ph: 042- 35790363-5
10.3	Currency	Bid shall be quoted entirely in Pak. Rupees. The payment shall be made in Pak. Rupees.
11.2	Evaluation and Qualification Criteria	Method of Selection: Least Cost Basis a) The Bidder must be registered with PEC with relevant code and category b) The Bidder must be registered FBR, Punjab Revenue Authority for Sales Tax and Income Tax and must be active taxpayer Copies of registration certificates to be attached. c) The bidding firm/company must be registered with SECP/Registrar of Firm. Copy of registration certificate(s) to be provided d) Bidder must have prior experience of at least 02 similar work. (Completion Certificate to be attached) e) In the case of JV. Proper JV agreement should be attached and both partners should be registered with FBR and PRA f) Bidder must not be blacklisted by any government office or autonomous body. In Case of JV, separate affidavit should be submitted for each partner
12.1	Work Description	See Technical Specification, and Specific Works Data
12.2	Technical	Complete set of technical information, description data, literature



	Information	and drawings as required in accordance with Schedule B to Bid, Specific Works Data. This will include but not be limited to a sufficient number of drawings, photographs, catalogues, illustrations and such other information as is necessary to illustrate clearly the significant characteristics such as general construction dimensions and other relevant information about the works to be performed.
13.1	Bid Security	PKR 600,000 in the form of CDR or Pay Order
14.1	Validity Period of Bid	90 Days
14.4	No. Of Copies:	Technical Bid: 01 (One) Original and 01 (One) Copy Financial Bid: 01 (One) Original
15.1	Deadline of Submission	Bids must be submitted by 02:00 PM on 22-March-2024 Bids submitted after the deadline shall not be accepted
16.1	Opening of Bid	Opening of Bids Bids shall be opened after 30 minutes of the deadline of submission Venue of Bid Opening Head Office of Quaid-e-Azam Solar Power (Pvt) Ltd. 3 rd Floor 83-A, E/1, Main Boulevard, Gulberg III, Lahore. Ph: 042- 35790363-5
16.4	Responsiveness of Bid	A responsive bid will be one which fulfills the following criteria (i) the Bid is valid till required period, (ii) the Bid prices are firm during currency of contract (iii) completion period offered is within specified limits, (iv) the Bidder/Manufacturer is eligible to Bid and possesses the requisite experience, capability and qualification. (v) the Bid does not deviate from basic technical requirements and (vi) the Bids are generally in order, etc. (vii) fulfills the Eligibility criteria IB.2
21.1	Performance Security	Equivalent to 10% of the contract amount to be submitted in Form of Bank Guaranty from any Scheduled Bank of Pakistan in name of Quaid-e-Azam Solar Power (Pvt.) Ltd.



Quaid-e-Azam Solar Power (Pvt) Ltd

FORM OF BID AND SCHEDULES TO BID

FORM OF BID
(LETTER OF OFFER)

Bid Reference No. _____

(Name of Works)

To:

Gentlemen,

1. Having examined the Bidding Documents including Instructions to Bidders, Conditions of Contract, Specifications, Drawings, Schedule of Prices and Addenda Nos. for the execution of the above-named Works, we, the undersigned, being a company doing business under the name of and address _____ and being duly incorporated under the laws of _____ hereby offer to execute and complete such Works and remedy any defects therein in conformity with the said Documents including Addenda thereto for the Total Bid Price as indicated in the Schedule of Prices placed in our Technical Bid envelop.
2. We understand that all the Schedules attached hereto form part of this Bid.
3. As security for due performance of the undertakings and obligations of this Bid, we submit herewith Bid Security (Rs _____) drawn in your favor or made payable to you and valid for a period twenty-eight (28) days beyond the period of validity of Bid.
4. We undertake, if our Bid is accepted, to commence the Works and to deliver and complete the whole of the Works comprised in the Contract within the time(s) stated in Preamble to the Conditions of Contract.
5. We agree to abide by this Bid for the period of 180 days from the date fixed for receiving the same and it shall remain binding upon us and may be accepted at any time before the expiration of that period.
6. Unless and until a formal Agreement is prepared and executed, this Bid, together with your written acceptance thereof, shall constitute a binding contract between us.
7. We undertake, if our Bid is accepted, to execute the Performance Security referred to Sub Clause 10.1 of Particular Conditions of Contract for the due performance of the Contract.
8. We understand that you are not bound to accept the lowest or any Bid you may receive.
9. We do hereby declare that the Bid is made without any collusion, comparison of



figures or arrangement with any other person or persons making a Bid

for the Works. Dated this _____ day of _____ 20_____

Signature _____ in the capacity of _____ duly

authorized to sign bids for and on behalf of _____
(Name of Bidder in Block Capitals)
(Seal)

Address

Witness:

(Signature) _____

(Name) _____

Address:

Occupation _____



SCHEDULES TO BID INCLUDE THE FOLLOWING:

- Schedule A to Bid: Schedule of Prices (BOQ) (To be Provided with Financial Bid)
- Schedule B to Bid: Specific Works Data
- Schedule C to Bid: Works to be Performed by Subcontractors
- Schedule D to Bid: Proposed Programme of Works
- Schedule E to Bid: Method of Performing Works
- Schedule F to Bid: Integrity Pact



SCHEDULE – A TO BID (SCHEDULE OF PRICES)

1. Schedule of Prices

Note: Price Should be inclusive of the following:

1. All applicable taxes/duties
2. Transport of Material/Labor
3. Labor Cost
4. Preparation of Site
5. Any other cost not mentioned hereabove



SCHEDULE OF PRICES – SUMMARY OF BID PRICES

Bill of Quantities

Item No.	Project Description	Total Cost of Construction Of Room PKR	Total Cost of Solar Equipment PKR	Total Cost of the Project PKR
1	CONSTRUCTION OF ONE (01) ROOM AROUND INVERTER AND BOX TRANSFORMER AT 100MW POWER PLANT OF QASPL IN BAHAWALPUR			



SCHEDULE OF PRICES

Sr #	Description	Unit	Total Qty	Item Rate	Amount (Rs.)
Ground Floor					
1	Excavation For Foundations	Cft	Job		
2	Termite Proofing in Excavated Area & Under Floor	Sft	Job		
3	PCC (1:4:8) Under Foundations	Cft	Job		
4	RCC 1:2:4 (Foundations)	Cft	Job		
5	RCC 1:2:4 (Plinth Beam)	Cft	Job		
6	RCC 1:1.5:3 (Columns)	Cft	Job		
7	Formwork (Overall)	Sft	Job		
8	Steel Reinforcement Structure	Kg's	Job		
9	Brick Work In Foundation (1:6)	Cft	Job		
10	Brick Work In Superstructure (1:5) (Cavity Walls)	Cft	Job		
11	Plaster Work (Internal Side)	Sft	Job		
12	Plaster Work (External Side)	Sft	Job		
13	Floor Works		Job		
i	Ghassu Filling Under Floor	Cft	Job		
ii	PCC 1:4:8 Under Floor (4" thick)	Cft	Job		
iii	RCC 1:2:4 in Floor (4" thick)	Cft	Job		
iv	Floor Steel #3@12" c/c	Kg's	Job		
v	Grit Topping (1" thick) with Grinding & Polishing	Sft	Job		
14	Roof MS sheet	Sft	Job		
15	Waterproofing of Roof (Inc. Insulation)	Sft	Job		
16	Electric Works (Conduits, Wire, Lights, Switch Plastes)	Sft	Job		
17	Main DB	Nos	Job		
18	RCC Stairs	Job	Job		
19	Aluminum Windows	Sft	Job		
20	Sliding Doors	Sft	Job		
21	Solar DC AC 1.5 Tons	Nos	3		
22	Solar Panel 570watt Tier 1 Grade A	watts	Job		
23	Mounting Structure with civil work, DC Wires, DB with protection, conduit pipes and Installation	watts	Job		
Grand Total Cost			Rs.		

Note: All Above Given Rates must be Inclusive of al

Important Notes:

- Construction of a Single Room Around Inverter and Box Transformer at the 100MW Power Plant of QASPL in Bahawalpur.
- The construction will involve cement walls with a ratio of 1:4.
- Roof slabs for the inverter room will be removable and must be both water and dustproof, utilizing appropriate seals. Proper insulation material will be incorporated into the roof for energy conservation.
- Windows in the room will be double-glazed for enhanced efficiency.
- Outdoor AC units will ideally be positioned in shaded areas; if not possible, a canopy-type structure will be constructed to provide cover.
- The main entrance door(s) of the inverter room will be made of insulated material and fitted with proper sealing mechanisms.
- The flooring will consist of tiled flooring with plaster applied to all walls.



and toilets.

- A one-foot parapet will be installed around the roof, encompassing both washrooms



SCHEDULE - B TO BID (SPECIFIC WORKS DATA)



SCHEDULE - B TO BID (SPECIFIC WORKS DATA)

Objective:

The primary goal of this project is to construct a specialized room tailored to house inverters and transformers within the 100MW Power Plant of QASPL in Bahawalpur. The paramount focus is on safeguarding these critical components against the adverse effects of both heat and severe weather conditions prevalent in the region.

Construction Tasks:

Erecting Sturdy Brick Walls: The construction will entail the meticulous erection of robust brick walls, meticulously crafted to withstand the harsh desert climate while offering superior insulation properties. This aspect is pivotal in ensuring the longevity and optimal functioning of the housed equipment.

Roof Structure Installation:

A carefully designed roof structure will be implemented, utilizing durable steel sheets complemented by openable slabs. This configuration is strategically engineered to facilitate convenient access to the inverters and transformers for maintenance purposes, while also ensuring adequate protection from external elements.

Incorporation of Thermopor Insulation:

To regulate internal temperature dynamics effectively, specialized THERMOPOOR insulation will be seamlessly integrated into the roof structure and walls. This insulation solution is chosen for its superior thermal properties, which contribute significantly to maintaining ideal operating conditions within the room.

Implementation of Solar-Powered Air Conditioning System:

An innovative solar-powered air conditioning system will be installed to regulate and maintain optimal temperature levels within the room. This sustainable solution not only reduces operational costs but also aligns with eco-friendly practices by harnessing solar energy, thereby minimizing the facility's carbon footprint.

Room Specifications:

Total Area Coverage:

The constructed room will encompass an area spanning approximately 1528.94 square feet, providing ample space for housing the designated equipment and accommodating necessary operational activities.

Cooling Capacity Requirements:

Based on meticulous calculations, it is determined that an estimated BTU of approximately 44,159 will be necessary to ensure efficient cooling within the designated space. Consequently, the installation of three 1.5-ton solar air conditioning units is deemed essential to meet these requirements effectively.

Benefits of Proposed Design:

Enhanced Durability and Insulation:

The utilization of sturdy brick walls coupled with advanced insulation materials ensures superior durability and thermal insulation, thereby safeguarding the equipment from external environmental stressors.



Enhanced Maintenance Accessibility:

The incorporation of a roof structure featuring openable slabs facilitates seamless access to the housed equipment, simplifying maintenance operations and minimizing downtime.

Cost-Effectiveness and Sustainability:

By harnessing solar energy to power the air conditioning system, the project not only reduces operational expenses but also underscores a commitment to sustainable practices, contributing to long-term cost savings and environmental conservation efforts.

Interior Design and Maintenance:

Optimized Layout and Ventilation: The interior layout will be meticulously designed to optimize operational efficiency and streamline maintenance activities. Additionally, strategically positioned ventilation systems will promote airflow and mitigate the risk of heat accumulation, further enhancing equipment performance and longevity.

Easy Equipment Access:

Emphasis will be placed on ensuring convenient access to the inverters and transformers, facilitating routine inspections and maintenance tasks to uphold operational integrity and minimize downtime effectively.



SCHEDULE – C TO BID (WORKS TO BE PERFORMED BY SUBCONTRACTORS)

The bidder will do the work with his own forces except the work listed below which he intends to sub-contract.

Items of Works to be Sub-Contracted	Name and address of Sub-Contractors	Statement of similar works previously executed (attach evidence)
-------------------------------------	-------------------------------------	--

Note:

1. No change of Sub-Contractors shall be made by the bidder without prior approval of the Employer.
2. The truthfulness and accuracy of the statement as to the experience of Sub-Contractors is guaranteed by the bidder. The Employer's judgment shall be final as to the evaluation of the experience of Sub-Contractors submitted by the bidder.
3. Statement of similar works shall include description, location & value of works, year completed and name & address of the clients.



SCHEDULE – D TO BID (PROPOSED PROGRAMME OF WORKS)

Bidder shall provide a programme in a bar-chart showing the sequence of work items by which he proposes to complete the Works of the entire Contract. The programme should indicate the sequence of work items and the period of time during which he proposes to complete the Works including the activities like designing, schedule of submittal of drawings, ordering and procurement of materials, manufacturing, delivering, construction of civil works, erection, testing and commissioning of Works to be supplied under the Contract.



SCHEDULE – E TO BID (METHOD OF PERFORMING WORKS)

The bidder is required to submit a narrative outlining the method of performing the Works. The narrative should indicate in detail and include but not be limited to:

- The sequence and methods in which he proposes to carry out the Works, including the number of shifts per day and hours per shift, he expects to work.
- A list of all major items of constructional and erectional plant, tools and vehicles proposed to be used in delivering/carrying out the Works at Site
- The procedure for installation of equipment and transportation of equipment and materials to the site.
- Organization chart indicating head office & field office personnel involved in management, supervision and engineering of the Works to be done under the Contract.



**Schedule F to Bid: Integrity Pact
(INTEGRITY PACT)**

**DECLARATION OF FEES, COMMISSION AND BROKERAGE ETC. PAYABLE BY THE
SUPPLIERS OF GOODS, SERVICES & WORKS IN CONTRACTS WORTH RS. 10.00
MILLION OR MORE**

Contract No. _____ Dated _____ Contract Value: __

Contract Title: _____

..... [name of Supplier] hereby declares that it has not obtained or induced the procurement of any contract, right, interest, privilege or other obligation or benefit from Government of Pakistan (GoP) or any administrative subdivision or agency thereof or any other entity owned or controlled by GoP through any corrupt business practice.

Without limiting the generality of the foregoing, [name of Supplier] represents and warrants that it has fully declared the brokerage, commission, fees etc. paid or payable to anyone and not given or agreed to give and shall not give or agree to give to anyone within or outside Pakistan either directly or indirectly through any natural or juridical person, including its affiliate, agent, associate, broker, consultant, director, promoter, shareholder, sponsor or subsidiary, any commission, gratification, bribe, finder's fee or kickback, whether described as consultation fee or otherwise, with the object of obtaining or inducing the procurement of a contract, right, interest, privilege or other obligation or benefit in whatsoever form from GoP, except that which has been expressly declared pursuant hereto.

[name of Supplier] certifies that it has made and will make full disclosure of all agreements and arrangements with all persons in respect of or related to the transaction with GoP and has not taken any action or will not take any action to circumvent the above declaration, representation or warranty.

[name of Supplier] accepts full responsibility and strict liability for making any false declaration, not making full disclosure, misrepresenting facts or taking any action likely to defeat the purpose of this declaration, representation and warranty. It agrees that any contract, right, interest, privilege or other obligation or benefit obtained or procured as aforesaid shall, without prejudice to any other rights and remedies available to GoP under any law, contract or other instrument, be voidable at the option of GoP.

Notwithstanding any rights and remedies exercised by GoP in this regard, [name of Supplier] agrees to indemnify GoP for any loss or damage incurred by it on account of its corrupt business practices and further pay compensation to GoP in an amount equivalent to ten times the sum of any commission, gratification, bribe, finder's fee or kickback given by [name of Supplier] as aforesaid for the purpose of obtaining or inducing the procurement of any contract, right, interest, privilege or other obligation or benefit in whatsoever form from GoP.

Name of Buyer:
Signature:
[Seal]

Name of Seller/Supplier:
Signature:
[Seal]



Quaid-e-Azam Solar Power (Pvt) Ltd

CONDITIONS OF CONTRACT & CONTRACT DATA



CONDITIONS OF CONTRACT

TABLE OF CONTENTS

CONDITIONS OF CONTRACT

Sr No.	Description	Page No.
1	General Provisions	35
2	The Employer	37
3	Engineer's/Employer's Representatives	37
4	The Contractor	38
5	Design by Contractor	38
6	Employer's Risks	39
7	Time for Completion	39
8	Taking Over	40
9	Remedying Defects	40
10	Variations And Claims	41
11	Contract Price And Payment	42
12	Default	43
13	Risks And Responsibilities	44
14	Insurance	45
15	Resolution of Disputes	45
16	Integrity Pact	46



CONDITIONS OF CONTRACT

1. GENERAL PROVISIONS

1.1 Definitions

In the Contract as defined below, the words and expressions defined shall have the following meanings assigned to them, except where the context requires otherwise:

The Contract

- 1.1.1 “Contract” means the Contract Agreement and the other documents listed in the Contract Data.
- 1.1.2 “Specifications” means the document as listed in the Contract Data, including Employer’s requirements in respect of design to be carried out by the Contractor (if any), and any Variation to such document.
- 1.1.3 “Drawings” means the Employer’s drawings of the Works as listed in the Contract Data, and any Variation to such drawings.

Persons

- 1.1.4 “Employer” means the person named in the Contract Data and the legal successors in title to this person, but not (except with the consent of the Contractor) any assignee.
- 1.1.5 “Contractor” means the person named in the Contract Data and the legal successors in title to this person, but not (except with the consent of the Employer) any assignee.
- 1.1.6 “Party” means either the Employer or the Contractor.

Dates, Times and Periods

- 1.1.7 “Commencement Date” means the date fourteen (14) days after the date the Contract comes into effect or any other date named in the Contract Data.
- 1.1.8 “Day” means a calendar day
- 1.1.9 “Time for Completion” means the time for completing the Works as stated in the Contract Data (or as extended under Sub-Clause 7.3), calculated from the Commencement Date.

Money and Payments

- 1.1.10 “Cost” means all expenditure properly incurred (or to be incurred) by the Contractor, whether on or off the Site, including overheads and similar charges but does not include any allowance for profit.



Other Definitions

- 1.1.11 “Contractor’s Equipment” means all machinery, apparatus and other things required for the execution of the Works but does not include Materials or Plant intended to form part of the Works.
- 1.1.12 “Country” means the Islamic Republic of Pakistan.
- 1.1.13 “Employer’s Risks” means those matters listed in Sub-Clause 6.1.
- 1.1.14 “Force Majeure” means an event or circumstance which makes performance of a Party’s obligations illegal or impracticable and which is beyond that Party’s reasonable control.
- 1.1.15 “Materials” means things of all kinds (other than Plant) to be supplied and incorporated in the Works by the Contractor.
- 1.1.16 “Plant” means the machinery and apparatus intended to form or forming part of the Works.
- 1.1.17 “Site” means the places provided by the Employer where the Works are to be executed, and any other places specified in the Contract as forming part of the Site.
- 1.1.18 “Variation” means a change which is instructed by the Engineer/Employer under Sub-Clause 10.1.
- 1.1.19 “Works” means any or all the works whether Supply, Installation, Construction etc. and design (if any) to be performed by the Contractor including temporary works and any variation thereof.
- 1.1.20 “Engineer” means the person notified by the Employer to act as Engineer for the purpose of the Contract and named as such in Contract Data.

1.2 Interpretation

Words importing persons or parties shall include firms and organizations. Words importing singular or one gender shall include plural or the other gender where the context requires.

1.3 Priority of Documents

The documents forming the Contract are to be taken as mutually explanatory of one another. If an ambiguity or discrepancy is found in the documents, the priority of the documents shall be in accordance with the order as listed in the Contract Data.

1.4 Law

The law of the Contract is the relevant Law of Islamic Republic of Pakistan.



1.5 Communications

All Communications related to the Contract shall be in English language.

1.6 Statutory Obligations

The Contractor shall comply with the Laws of Islamic Republic of Pakistan and shall give all notices and pay all fees and other charges in respect of the Works.

2. THE EMPLOYER

2.1 Provision of Site

The Employer shall provide the Site and right of access thereto at the times stated in the Contract Data.

2.2 Permits etc.

The Employer shall, if requested by the Contractor, assist him in applying for permits, licences or approvals which are required for the Works.

2.3 Engineer's/Employer's Instructions

The Contractor shall comply with all instructions given by the Employer or the Engineer, if notified by the Employer, in respect of the Works including the suspension of all or part of the Works.

2.4 Approvals

No approval or consent or absence of comment by the Engineer/Employer shall affect the Contractor's obligations.

3. ENGINEER'S/EMPLOYER'S REPRESENTATIVES

3.1 Authorized Person

The Employer shall appoint a duly authorized person to act for him and on his behalf for the purposes of this Contract. Such authorized person shall be duly identified in the Contract Data or otherwise notified in writing to the Contractor as soon as he is so appointed. In either case the Employer shall notify the Contractor, in writing, the precise scope of the authority of such authorized person at the time of his appointment.

3.2 Engineer's/Employer's Representative

The name and address of Engineer's/Employer's Representative is given in Contract Data. However, the Contractor shall be notified by the Engineer/Employer, the delegated duties and authority before the Commencement of Works.



4. THE CONTRACTOR

4.1 General Obligations

The Contractor shall carry out the Works properly and in accordance with the Contract. The Contractor shall provide all supervision, labor, Materials, Plant and Contractor's Equipment which may be required.

4.2 Contractor's Representative

The Contractor shall appoint a representative at site on full time basis to supervise the execution of work and to receive instructions on behalf of the Contractor but only after obtaining the consent of the Employer for such appointment which consent shall not be unreasonable withheld by the Employer. Such authorized representative may be substituted/replaced by the Contractor at any time during the Contract Period but only after obtaining the consent of the Employer as aforesaid.

4.3 Subcontracting

The Contractor shall not subcontract the whole of the Works. The Contractor shall not subcontract any part of the Works without the consent of the Employer.

4.4 Performance Security

The Contractor shall furnish to the Employer within fourteen (14) days after receipt of Letter of Acceptance a Performance Security @ 10% of the contract amount at the option of the bidder, in the form of Bank Draft or Bank Guarantee for the amount and validity specified in Contract Data.

5. DESIGN BY CONTRACTOR

5.1 Contractor's Design

The Contractor shall carry out design to the extent specified, as referred to in the Contract Data. The Contractor shall promptly submit to the Engineer/Employer all designs prepared by him. Within fourteen (14) days of receipt the Engineer/Employer shall notify any comments or, if the design submitted is not in accordance with the Contract, shall reject it stating the reasons. The Contractor shall not construct any element of the Works designed by him within fourteen (14) days after the design has been submitted to the Engineer/Employer or which has been rejected. Design that has been rejected shall be promptly amended and resubmitted. The Contractor shall resubmit all designs commented on taking these comments into account as necessary.

5.2 Responsibility for Design

The Contractor shall remain responsible for his bided design and the design under this Clause, both of which shall be fit for the intended purposes defined in the Contract and he shall also remain responsible for any infringement of any patent or copyright in respect of the same. The Engineer/Employer shall be responsible for the Specifications and Drawings.



6. EMPLOYER'S RISKS

6.1 The Employer's Risks

The Employer's Risks are: -

- a) war, hostilities (whether war be declared or not), invasion, act of foreign enemies, within the Country;
- b) rebellion, terrorism, revolution, insurrection, military or usurped power, or civil war, within the Country;
- c) riot, commotion or disorder by persons other than the Contractor's personnel and other employees including the personnel and employees of Sub-Contractors, affecting the Site and/or the Works;
- d) ionizing radiations, or contamination by radio-activity from any nuclear fuel, or from any nuclear waste from the combustion of nuclear fuel, radio-active toxic explosive, or other hazardous properties of any explosive nuclear assembly or nuclear component of such an assembly, except to the extent to which the Contractor/Sub-Contractors may be responsible for the use of any radio-active material;
- e) Pressure waves caused by aircraft or other aerial devices travelling at sonic or supersonic speeds;
- f) use or occupation by the Employer of any part of the Works, except as may be specified in the Contract;
- g) late handing over of sites, anomalies in drawings, late delivery of designs and drawings of any part of the Works by the Employer's personnel or by others for whom the Employer is responsible;
- h) a suspension under Sub-Clause 2.3 unless it is attributable to the Contractor's failure; and
- i) physical obstructions or physical conditions other than climatic conditions, encountered on the Site during the performance of the Works, for which the Contractor immediately notified to the Employer and accepted by the Employer.

7. TIME FOR COMPLETION

7.1 Execution of the Works

The Contractor shall commence the Works on the Commencement Date and shall proceed expeditiously and without delay and shall complete the Works, subject to Sub-Clause 7.3 below, within the Time for Completion.

7.2 Programme

Within the time stated in the Contract Data, the Contractor shall submit to the Engineer/Employer a programme for the Works in the form stated in the Contract Data.



7.3 Extension of Time

The Contractor shall, within such time as may be reasonable under the circumstances, notify the Employer/Engineer of any event(s) falling within the scope of Sub-Clause 6.1 or 10.3 of these Conditions of Contract and request the Employer/Engineer for a reasonable extension in the time for the completion of Works. Subject to the aforesaid, the Employer/Engineer shall determine such reasonable extension in the time for the completion of Works as may be justified in the light of the details/particulars supplied by the Contractor in connection with the such determination by the Employer/Engineer within such period as may be prescribed by the Employer/Engineer for the same; and

the Employer shall extend the Time for Completion as determined.

7.4 Late Completion

If the Contractor fails to complete the Works within the Time for Completion, the Contractor's only liability to the Employer for such failure shall be to pay the amount stated in the Contract Data for each day for which he fails to complete the Works.

8. TAKING-OVER

8.1 Completion

The Contractor may notify the Engineer/Employer when he considers that the Works are complete.

8.2 Taking-Over Notice

Within fourteen (14) days of the receipt of the said notice of completion from the Contractor the Employer/Engineer shall either takeover the completed Works and issue a Certificate of Completion to that effect or shall notify the Contractor his reasons for not taking-over the Works. While issuing the Certificate of Completion as aforesaid, the Employer/Engineer may identify any outstanding items of work which the Contractor shall undertake during the Maintenances Period.

9. REMEDYING DEFECTS

9.1 Remediating Defects

The Contractor shall for a period stated in the Contract Data from the date of issue of the Certificate of Completion carry out, at no cost to the Employer, repair and rectification work which is necessitated by the earlier execution of poor quality of work or use of below specifications material in the execution of Works and which is so identified by the Employer/Engineer in writing within the said period. Upon expiry of the said period, and subject to the Contractor's faithfully performing his aforesaid obligations, the Employer/Engineer shall issue a Maintenance Certificate whereupon all obligations of the Contractor under this Contract shall come to an end.

Failure to remedy any such defects or complete outstanding work within a



reasonable time shall entitle the Employer to carry out all necessary works at the Contractor's cost. However, the cost of remedying defects not attributable to the Contractor shall be valued as a Variation.

9.2 Uncovering and Testing

The Engineer/Employer may give instruction as to the uncovering and/or testing of any work. Unless as a result of an uncovering and/or testing it is established that the Contractor's design, Materials, Plant or workmanship are not in accordance with the Contract, the Contractor shall be paid for such uncovering and/or testing as a Variation in accordance with Sub-Clause 10.2.

10. VARIATIONS AND CLAIMS

10.1 Right to Vary

The Employer/Engineer may issue Variation Order(s) in writing. Where for any reason it has not been possible for the Employer/Engineer to issue such Variations Order(s), the Contractor may confirm any verbal orders given by the Employer/Engineer in writing and if the same are not refuted/denied by the Employer/Engineer within seven (7) days of the receipt of such confirmation the same shall be deemed to be a Variation Orders for the purposes of this Sub- Clause.

10.2 Valuation of Variations

Variations shall be valued as follows:

- a) at a lump sum price agreed between the Parties, or
- b) where appropriate, at rates in the Contract, or
- c) in the absence of appropriate rates, the rates in the Contract shall be used as the basis for valuation, or failing which
- d) at appropriate new rates, as may be agreed or which the Engineer/Employer considers appropriate, or
- e) if the Engineer/Employer so instructs, at day work rates set out in the Contract Data for which the Contractor shall keep records of hours of labour and Contractor's Equipment, and of Materials, used, or
- f) Market Rate System (MRS) District Lahore issued by Govt. of the Punjab Finance Department.

10.3 Early Warning

The Contractor shall notify the Engineer/Employer in writing as soon as he is aware of any circumstance which may delay or disrupt the Works, or which may give rise to a claim for additional payment.

To the extent of the Contractor's failure to notify, which results to the



Engineer/Employer being unable to keep all relevant records or not taking steps to minimize any delay, disruption, or Cost, or the value of any Variation, the Contractor's entitlement to extension of the Time for Completion or additional payment shall be reduced/rejected.

10.4 Valuation of Claims

If the Contractor incurs Cost as a result of any of the Employer's Risks, the Contractor shall be entitled to the amount of such Cost. If as a result of any Employer's Risk, it is necessary to change the Works, this shall be dealt with as a Variation subject to Contractor's notification for intention of claim to the Engineer/Employer within fourteen (14) days of the occurrence of cause.

10.5 Variation and Claim Procedure

The Contractor shall submit to the Engineer/Employer an itemized make-up of the value of variations and claims within twenty-eight (28) days of the instruction or of the event giving rise to the claim. The Engineer/Employer shall check and if possible, agree the value. In the absence of agreement, the Employer shall determine the value.

11. CONTRACT PRICE AND PAYMENT

11.1 Terms of Payments and Valuation of Work

(a) Terms of Payment

The amount due to the Contractor under any Interim Payment Certificate issued by the Engineer pursuant to this Clause, or to any other terms of the Contract, shall , subject to Clause 47, be paid by the Employer to the Contractor within 30 days after such Interim Payment Certificate has been jointly verified by Employer and Contractor, or, in the case of the Final Certificate referred to in Sub Clause 60.8, within 60 days after such Final Payment Certificate has been jointly verified by Employer and Contractor; Provided that the Interim Payment shall be caused in 42 days and Final Payment in 60 days in case of foreign funded project

(b) Valuation of the Works

The Works shall be valued as provided for in the Contract Data, subject to Clause 10.

11.2 Monthly Statements

The Contractor shall be entitled to be paid at monthly intervals:

- a) the value of the Works executed; and
- b) The percentage of the value of Materials and Plant reasonably delivered to the Site, as stated in the Contract Data, subject to any additions or deductions which may be due.

The Contractor shall submit each month to the Engineer/Employer a statement showing the amounts to which he considers himself entitled.

11.3 Interim Payments



Within a period not exceeding seven (7) days from the date of submission of a statement for interim payment by the Contractor, the Engineer shall verify the same and within a period not exceeding thirty (30) days from the said date of submission by the Contractor, the Employer shall pay to the Contractor the sum verified by the Engineer less retention money at the rate stated in the Contract Data.

11.4 Retention

Retention money shall be paid by the Employer to the Contractor within fourteen (14) Days after either the expiry of the period stated in the Contract Data, or the remedying of notified defects, or the completion of outstanding work, all as referred to in Sub-Clause 9.1, whichever is the later.

11.5 Final Payment

Within twenty-one (21) days from the date of issuance of the Maintenance Certificate the Contractor shall submit a final account to the Engineer to verify and the Engineer shall verify the same within fourteen (14) days from the date of submission and forward the same to the Employer together with any documentation reasonably required to enable the Employer to ascertain the final contract value.

Within sixty (60) days from the date of receipt of the verified final account from the Engineer, the Employer shall pay to the Contractor any amount due to the Contractor. While making such payment the Employer may, for reasons to be given to the Contractor in writing, withhold any part or parts of the verified amount.

11.6 Currency

Payment shall be in the currency stated in the Contract Data.

12. DEFAULT

12.1 Default by Contractor

If the Contractor abandons the Works, refuses or fails to comply with a valid instruction of the Engineer/Employer or fails to proceed expeditiously and without delay, or is, despite a written complaint, in breach of the Contract, the Employer may give notice referring to this Sub-Clause and stating the default.

If the Contractor has not taken all practicable steps to remedy the default within fourteen (14) days after receipt of the Employer's notice, the Employer may by a second notice given within a further twenty-one (21) days, terminate the Contract. The Contractor shall then demobilize from the Site leaving behind any Contractor's Equipment which the Employer instructs, in the second notice, to be used for the completion of the Works at the risk and cost of the Contractor.

12.2 Default by Employer

If the Employer fails to pay in accordance with the Contract, or is, despite a written complaint, in breach of the Contract, the Contractor may give notice referring to this Sub-Clause and stating the default. If the default is not remedied within fourteen (14) days after the Employer's receipt of this notice, the Contractor may suspend the



execution of all or parts of the Works.

If the default is not remedied within twenty-eight (28) days after the Employer's receipt of the Contractor's notice, the Contractor may by a second notice given within a further twenty-one (21) days, terminate the Contract. The Contractor shall then demobilize from the Site.

12.3 Insolvency

If a Party is declared insolvent under any applicable law, the other Party may by notice terminate the Contract immediately. The Contractor shall then demobilize from the Site leaving behind, in the case of the Contractor's insolvency, any Contractor's Equipment which the Employer instructs in the notice is to be used for the completion of the Works.

12.4 Payment upon Termination

After termination, the Contractor shall be entitled to payment of the unpaid balance of the value of the Works executed and of the Materials and Plant reasonably delivered to the Site, adjusted by the following:

- a) any sums to which the Contractor is entitled under Sub-Clause 10.4,
- b) any sums to which the Employer is entitled,
- c) if the Employer has terminated under Sub-Clause 12.1 or 12.3, the Employer shall be entitled to a sum equivalent to twenty percent (20%) of the value of parts of the Works not executed at the date of the termination, and
- d) if the Contractor has terminated under Sub-Clause 12.2 or 12.3, the Contractor shall be entitled to the cost of his demobilization together with a sum equivalent to ten percent (10%) of the value of parts of the Works not executed at the date of termination.

The net balance due shall be paid or repaid within twenty-eight (28) days of the notice of termination.

13. RISKS AND RESPONSIBILITIES

13.1 Contractor's Care of the Works

Subject to Sub-Clause 9.1, the Contractor shall take full responsibility for the care of the Works from the Commencement Date until the date of the Employer's/Engineer's issuance of Certificate of Completion under Sub-Clause

8.2. Responsibility shall then pass to the Employer. If any loss or damage happens to the Works during the above period, the Contractor shall rectify such loss or damage so that the Works conform with the Contract.

Unless the loss or damage happens as a result of any of the Employer's Risks, the



Contractor shall indemnify the Employer, or his agents against all claims, loss, damage and expense arising out of the Works.

13.2 Force Majeure

If Force Majeure occurs, the Contractor shall notify the Engineer/Employer immediately. If necessary, the Contractor may suspend the execution of the Works and, to the extent agreed with the Employer demobilize the Contractor's Equipment.

If the event continues for a period of eighty-four (84) days, either Party may then give notice of termination which shall take effect twenty eight (28) days after the giving of the notice.

After termination, the Contractor shall be entitled to payment of the unpaid balance of the value of the Works executed and of the Materials and Plant reasonably delivered to the Site, adjusted by the following:

- a) any sums to which the Contractor is entitled under Sub-Clause 10.4,
- b) the cost of his demobilization, and
- c) less any sums to which the Employer is entitled.

The net balance due shall be paid or repaid within thirty five (35) days of the notice of termination.

14. INSURANCE

14.1 Arrangements

The Contractor shall, prior to commencing the Works, effect insurances of the types, in the amounts and naming as insured the persons stipulated in the Contract Data except for items (a) to (e) and (i) of the Employer's Risks under Sub-Clause 6.1. The policies shall be issued by insurers and in terms approved by the Employer. The Contractor shall provide the Engineer/Employer with evidence that any required policy is in force and that the premiums have been paid.

14.2 Default

If the Contractor fails to effect or keep in force any of the insurances referred to in the previous Sub-Clause, or fails to provide satisfactory evidence, policies or receipts, the Employer may, without prejudice to any other right or remedy, effect insurance for the cover relevant to such as a default and pay the premiums due and recover the same plus a sum in percentage given in Contractor Data from any other amounts due to the Contractor.

15. RESOLUTION OF DISPUTES

15.1 Engineer's Decision

If a dispute of any kind whatsoever arises between the Employer and the Contractor



in connection with the Works, the matter in dispute shall, in the first place, be referred in writing to the Engineer, with a copy to the other party. Such reference shall state that it is made pursuant to this Clause. No later than the twenty eight (28) days after the day on which he received such reference, the Engineer shall give notice of his decision to the Employer and the Contractor.

Unless the Contract has already been repudiated or terminated, the Contractor shall, in every case, continue to proceed with the Work with all due diligence, and the Contractor and the Employer shall give effect forthwith to every such decision of the Engineer unless and until the same shall be revised, as hereinafter provided in an arbitral award.

15.2 Notice of Dissatisfaction

If a Party is dissatisfied with the decision of the Engineer or if no decision is given within the time set out in Sub-Clause 15.1 here above, the Party may give notice of dissatisfaction referring to this Sub-Clause within fourteen (14) days of receipt of the decision or the expiry of the time for the decision. If no notice of dissatisfaction is given within the specified time, the decision shall be final and binding on the Parties. If notice of dissatisfaction is given within the specified time, the decision shall be binding on the Parties who shall give effect to it without delay unless and until the decision of the Engineer is revised by an arbitrator.

15.3 Arbitration

A dispute which has been the subject of a notice of dissatisfaction shall be finally settled as per provisions of Arbitration Act 1940 (Act No. X of 1940) and Rules made thereunder and any statutory modifications thereto. Any hearing shall be held at the place specified in the Contract Data and in the language referred to in Sub-Clause 1.5.

16. INTEGRITY PACT

16.1 If the Contractor, or any of his Sub-Contractors, agents or servants is found to have violated or involved in violation of the Integrity Pact signed by the Contractor as Schedule-F to his Bid, then the Employer shall be entitled to:

- (a) recover from the Contractor an amount equivalent to ten times the sum of any commission, gratification, bribe, finder's fee or kickback given by the Contractor or any of his Sub-Contractors, agents or servants;
- (b) terminate the Contract; and
- (c) Recover from the Contractor any loss or damage to the Employer as a result of such termination or of any other corrupt business practices of the Contractor or any of his Sub-Contractors, agents or servants.

On termination of the Contract under Sub-Para (b) of this Sub-Clause, the Contractor shall demobilize from the Site leaving behind Contractor's Equipment which the Employer instructs, in the termination notice, to be used for the completion of the Works at the risk and cost of the Contractor. Payment upon such termination shall be made under



Sub-Clause 12.4, in accordance with Sub-Para (c) thereof, after having deducted the amounts due to the Employer under Sub-Para (a) and (c) of this Sub-Clause.

17. Liquidated Damages for Delay

If the Contractor fails to comply with the Time for Completion in accordance with Clause 48, for the whole of the Works or, if applicable, any Section within the relevant time prescribed in the Contract, then the Contractor shall pay to the Employer the relevant sum stated in the Contract Data as liquidated damages for such default and not as a penalty (which sum shall be the only monies due from the Contractor for such default) for every day or part of a day which shall elapse between the relevant Time for Completion and the date stated in a Taking-Over Certificate of the whole of the Works or the relevant Section, subject to the applicable limit stated in the Appendix to Tender. The Employer may, without prejudice to any other method of recovery, deduct the amount of such damages from any monies due or to become due to the Contractor. The payment or deduction of such damages shall not relieve the Contractor from his obligation to complete the Works, or from any other of his obligations and liabilities under the Contract.



CONTRACT DATA

Conditions of Contract

1.1.4 The Employer means;

Chief Executive officer (CEO)- Quaid-e-Azam Solar Power (Pvt) Ltd.
3rd Floor 83-A, E/1,
Main Boulevard, Gulberg 111.
Lahore.
Ph: 042- 35790363-5

1.1.5 The Contractor means;

CONSTRUCTION OF ONE (01) ROOM AROUND INVERTER AND BOX
TRANSFORMER AT 100MW POWER PLANT OF QASPL IN BAHAWALPUR

1.1.7 Commencement Date means;

The date given in the Letter of Award / Acceptance.

1.1.9 **Time for Completion:** Three (03) Months.

1.1.20 The Engineer:

GM Plant/Civil Consultant

1.3 Documents forming the Contract listed in the order of priority:

- (a) The Contract Agreement
- (b) Letter of Acceptance
- (c) The completed Form of Bid
- (d) Contract Data
- (e) Conditions of Contract
- (f) The completed Schedules to Bid including Schedule of Prices
- (g) The Drawings, if any
- (h) The Specifications
- (i) _____
- (j) _____

2.1 Provision of Site:

Date of Commencement will be The Date for provision of Site.

3.1 Authorized person:

General Manager (Technical), QASPL

3.2 Name and address of Engineer's / Employer's representative



3.3 Performance Security:

10% of the Contract Amount in shape of Bank Guarantee issued by a Scheduled Bank in Pakistan

Validity: Performance Security will remain valid till successful completion of project

5.1 Requirements for Contractor's design (if any):

Not Applicable

7.2 Programme:

Time for submission:

Within Ten (10) days of the receipt of Acceptance Letter.

9.1 Period for remedying defects

Minimum 12-months effective from issuance of Taking Over Certificate.

11.1 Terms of Payments

Add following at the end of paragraph 11.1 (a)

“The quantities given in the BOQ are merely estimation. Payment to the Contractor shall be made as per actual work done fully verified by the Representative of the Engineer and certified by the “The Engineer” of the Project.”

11.3 Percentage of retention:

11.6 Currency of payment:

Pak. Rupees

14.1 Insurances:

Type of cover

The Works,

Amount of cover

The sum stated in the Letter of Acceptance plus fifteen percent (15%)

Type of cover

Contractor's Equipment:

Amount of cover

Full replacement cost

Type of cover

Third Party-injury to persons and damage to property.



Amount of cover

Pak Rupees 50,000.00 per occurrence with number of occurrences unlimited

15.3 Arbitration

Place of Arbitration: Lahore.

17. Liquidated Damages for Delay

In the fifth line of Sub-clause deletes the words “and not as penalty”

Add the following paragraph at the end of Sub-Clause

The rate of liquidated damages shall be at the rate of 0.1 Percent per day up to maximum of Ten (10) Percent of Contract Price).



Quaid-e-Azam Solar Power (Pvt) Ltd

STANDARD FORMS



FORM OF PERFORMANCE SECURITY (Bank Guarantee)

As Provided by the Bank



FORM OF CONTRACT AGREEMENT

THIS CONTRACT AGREEMENT (hereinafter called the “Agreement”) made on the day of _____ 20____ between _____(hereinafter called the “Employer”) of the one part and _____(hereinafter called the “Contractor”) of the other part.

WHEREAS the Employer is desirous that certain Works, viz _____should be executed by the Contractor and has accepted a Bid by the Contractor for the execution and completion of such Works and the remedying of any defects therein.

NOW this Agreement witnessed as follows:

1. In this Agreement words and expressions shall have the same meanings as are respectively assigned to them in the Conditions of Contract hereinafter referred to.
2. The following documents after incorporating addenda, if any except those parts relating to Instructions to Bidders, shall be deemed to form and be read and construed as part of this Agreement, viz:
 - (a) The Letter of Acceptance;
 - (b) The completed Form of Bid along with Schedules to Bid;
 - (c) Conditions of Contract & Contract Data;
 - (d) The priced Schedule of Prices;
 - (e) The Specifications; and
 - (f) The Drawings
3. In consideration of the payments to be made by the Employer to the Contractor as hereinafter mentioned, the Contractor hereby covenants with the Employer to execute and complete the Works and remedy defects therein in conformity and in all respects within the provisions of the Contract.
4. The Employer hereby covenants to pay the Contractor, in consideration of the execution and completion of the Works as per provisions of the Contract, the Contract Price or such other sum as may become payable under the provisions of the Contract at the times and in the manner prescribed by the Contract.



IN WITNESS WHEREOF the parties hereto have caused this Contract Agreement to be executed on the day, month and year first before written in accordance with their respective laws.

Signature of the Contactor

(Seal)

Signature of the Employer

(Seal)

Signed, Sealed and Delivered in the presence of:

Witness:

(Name, Title and Address)

Witness:

(Name, Title and Address)



Quaid-e-Azam Solar Power (Pvt) Ltd

Affidavit for Non-Blacklisting of Firm

(In case of JV separate certificate to be attached by each member)



[PRINT ON STAMP PAPER]
Non-judicial stamp paper (with a value of Rs. 100)

Date: _____

AFFIDAVIT

It is hereby solemnly confirmed and declared that M/s -----, is
declaring on oath that the Applicant:

- is not in bankruptcy or liquidation proceedings;
- has *never* been declared ineligible/blacklisted by Government / Semi-Government / Agency or Authority or any employer till date due to the any reasons
- is not making any misrepresentations or concealing any material fact and detail;
- has not been convicted of, fraud, corruption, collusion or money laundering;
- is not aware of any conflict of interest or potential conflict of interest arising from prior or existing contracts or relationships which could materially affect its capability to comply with its obligations; and
- does not fall within any of the circumstances for ineligibility or disqualifications

(Stamp of Company)

(Signatures of Authorized Rep)

Company Name

Attestation by Oath Commissioner and/or Notary Public



ANNEX A: TECHNICAL SPECIFICATIONS



Sr.#	Description/Specifications
1	Cement brand will be Maple Leaf/equivalent
2	Sand will be Ravi /Equivalent
3	Bricks -Awwal with good quality
4	Crush- Chiniot/Equivalent
5	Plaster Ratio-1:4
6	Masonry Work Cement Ratio- 1:4
7	Lights- LED Phillips/Equivalent
8	Cable- Pak Cable/Equivalent
9	Tiles-Master/Equivalent
10	Air Conditioners-Haier/Equivalent

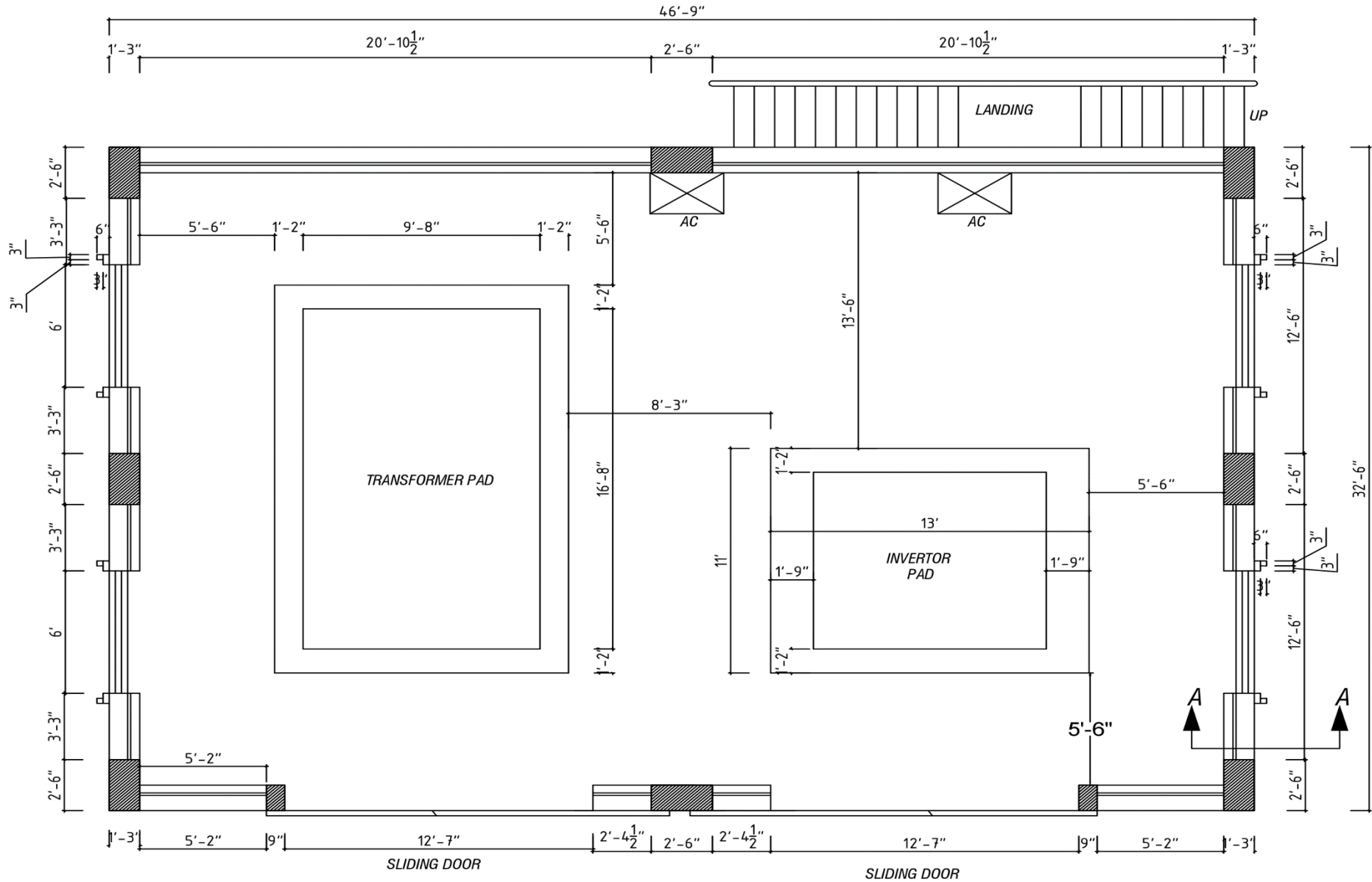

GROUND FLOOR WORKING
(1519.375 square ft.)

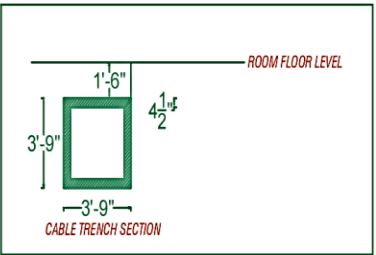
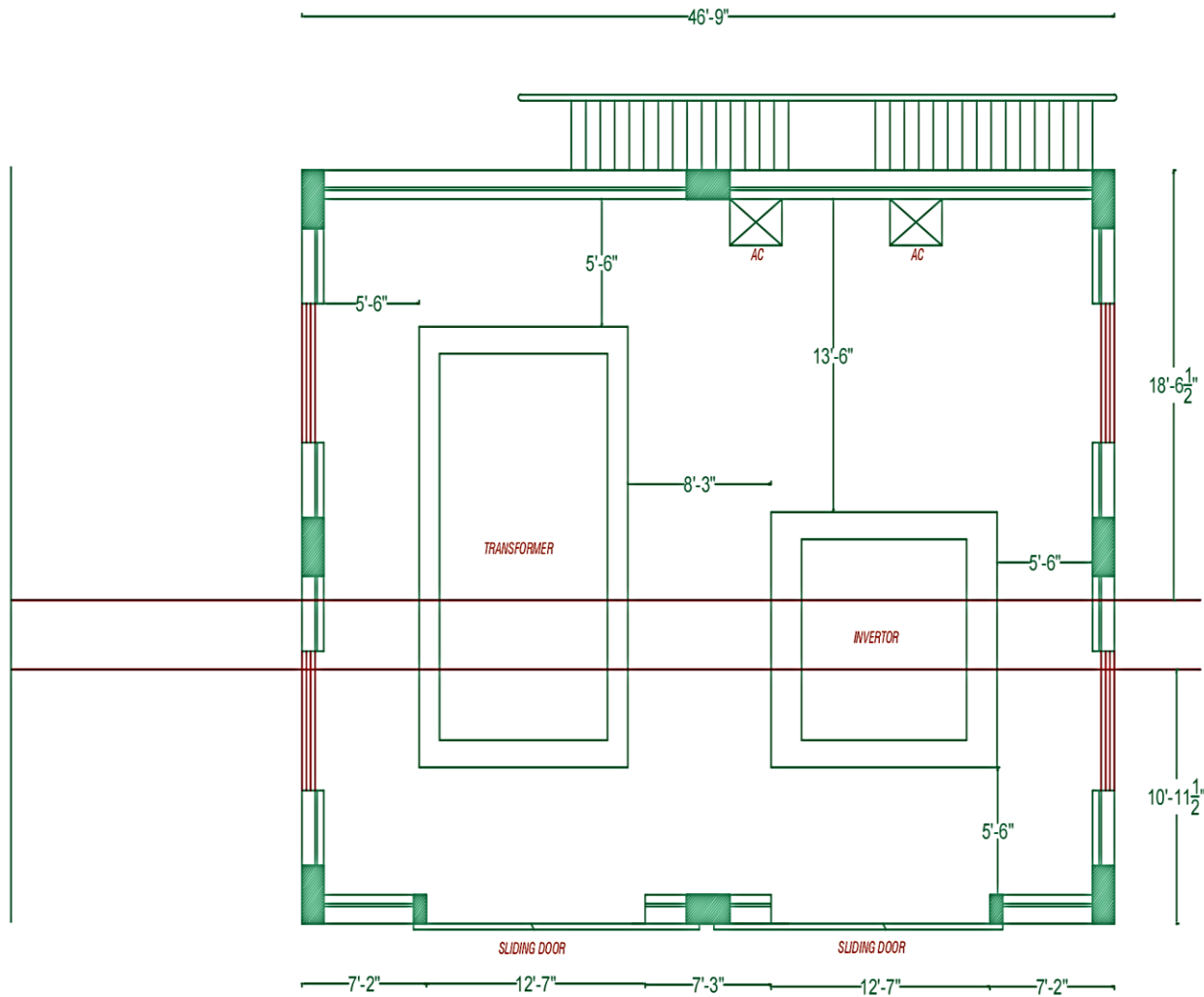

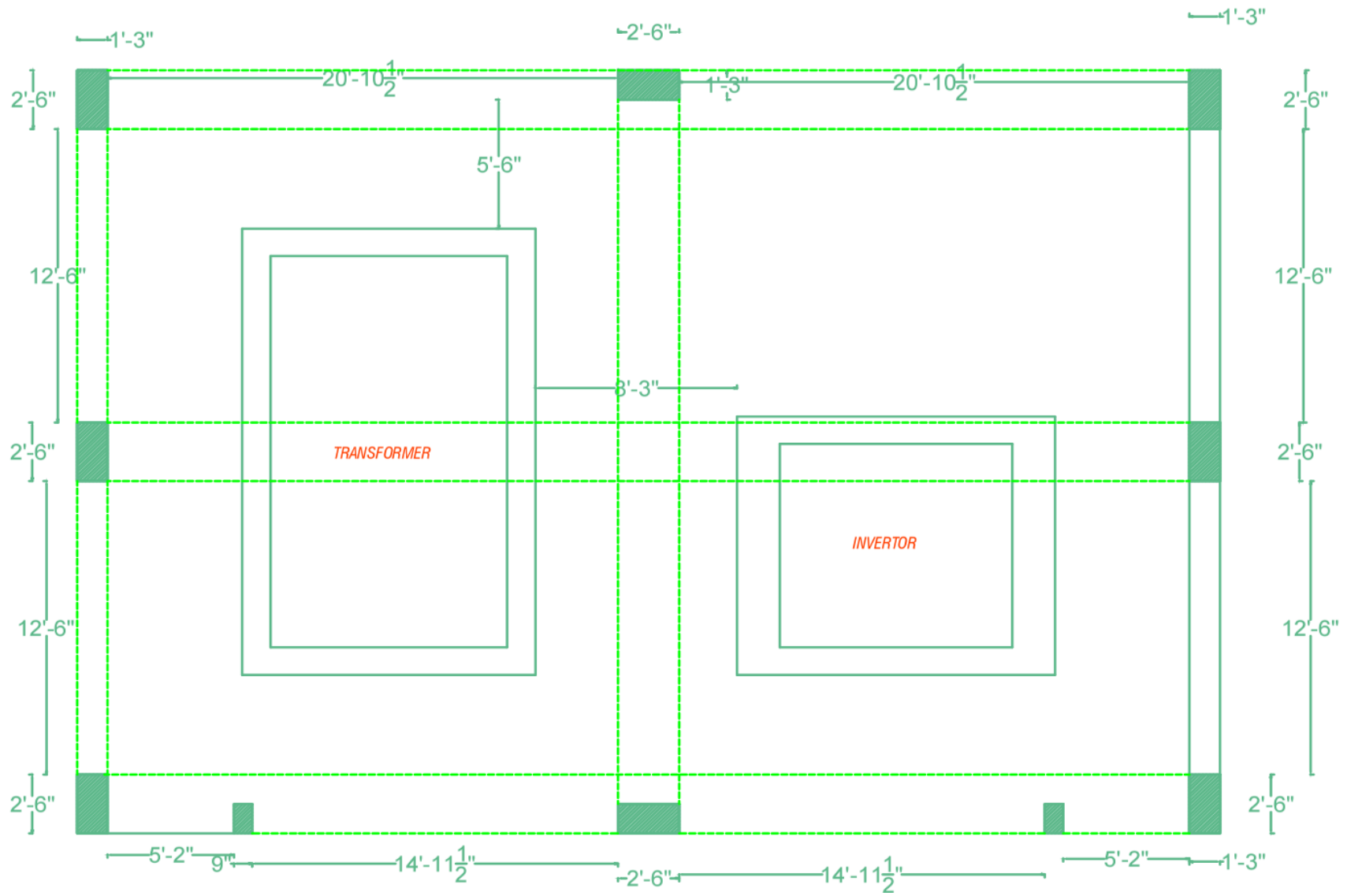

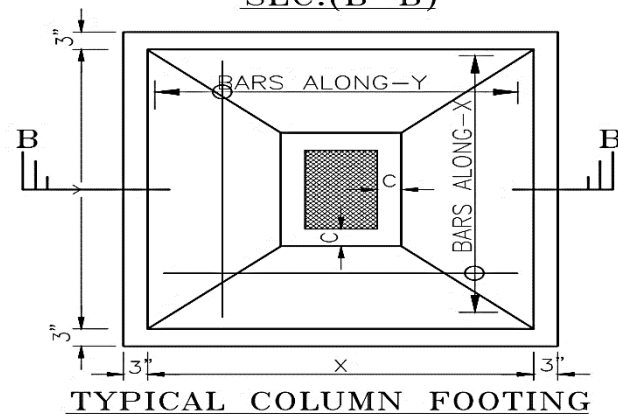
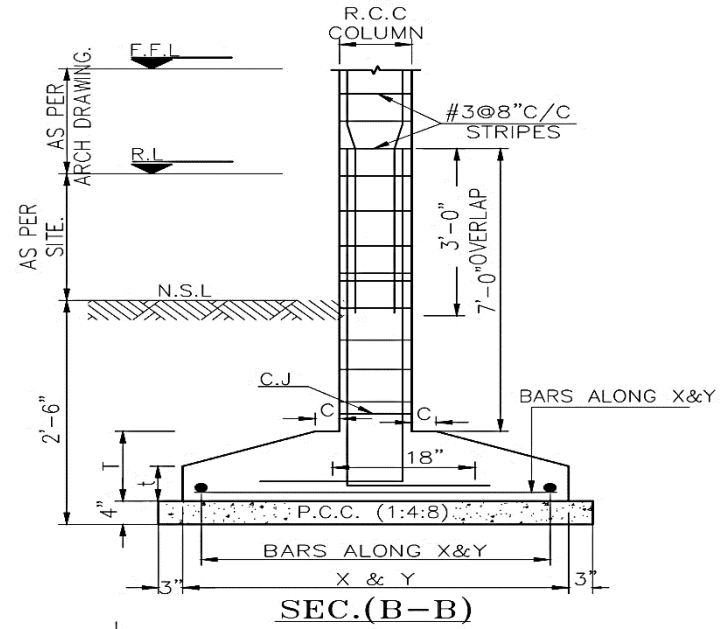
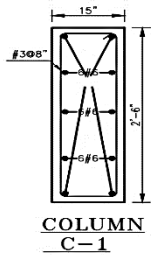
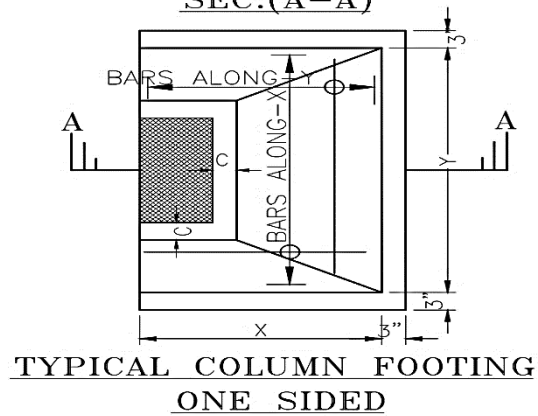
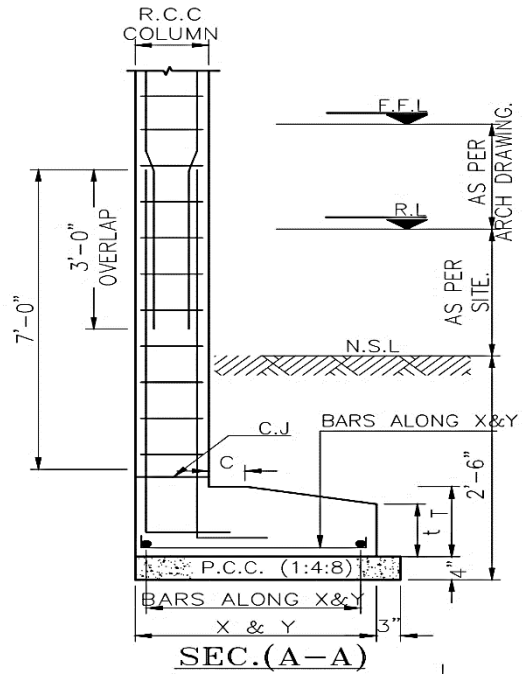

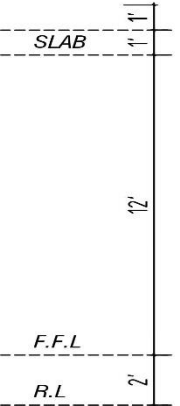
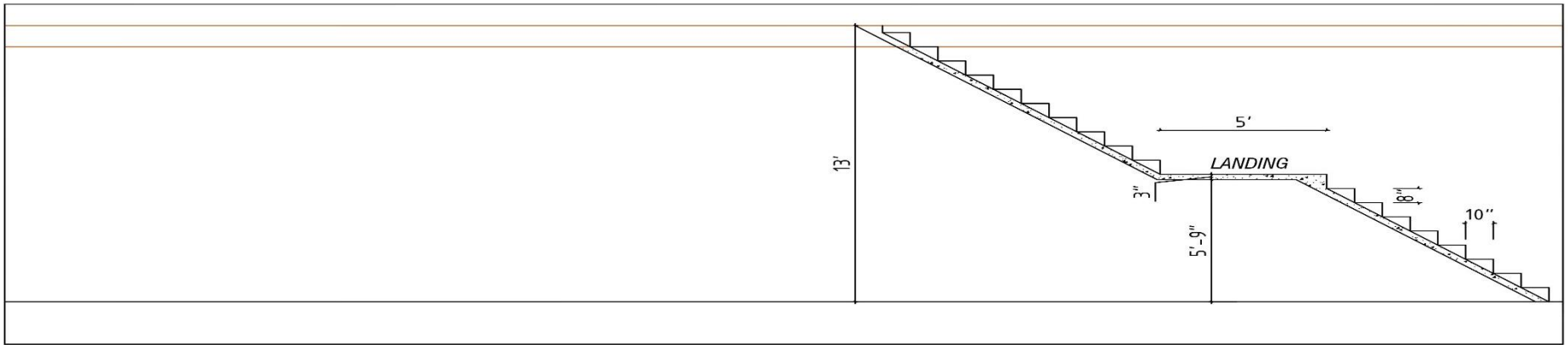

CROSS SECTION

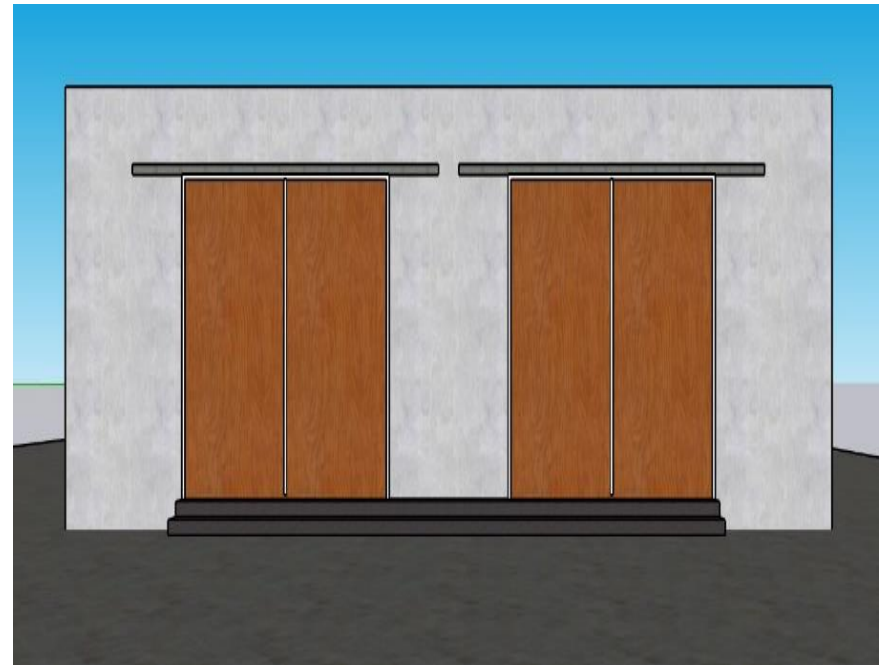
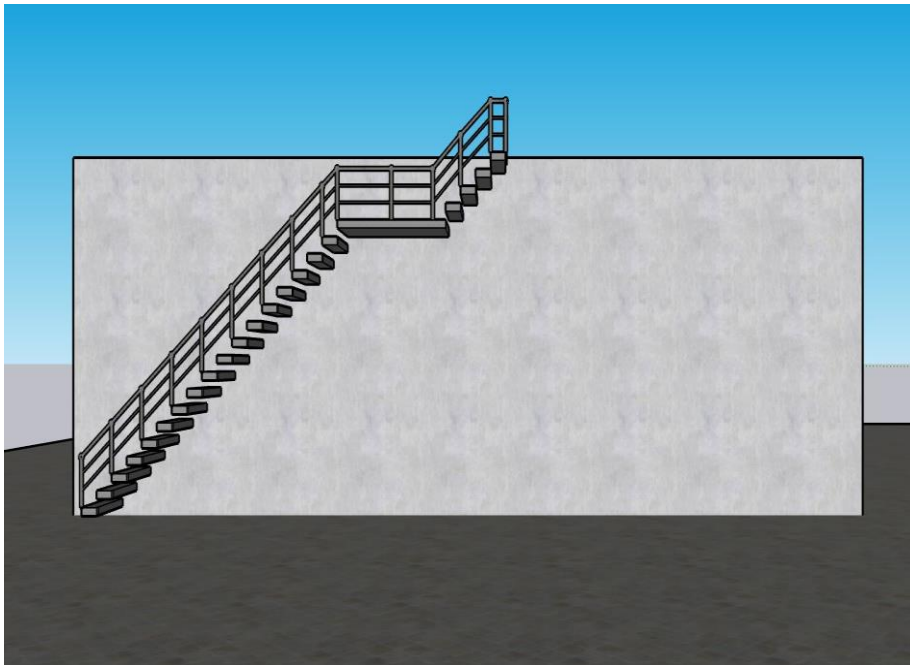
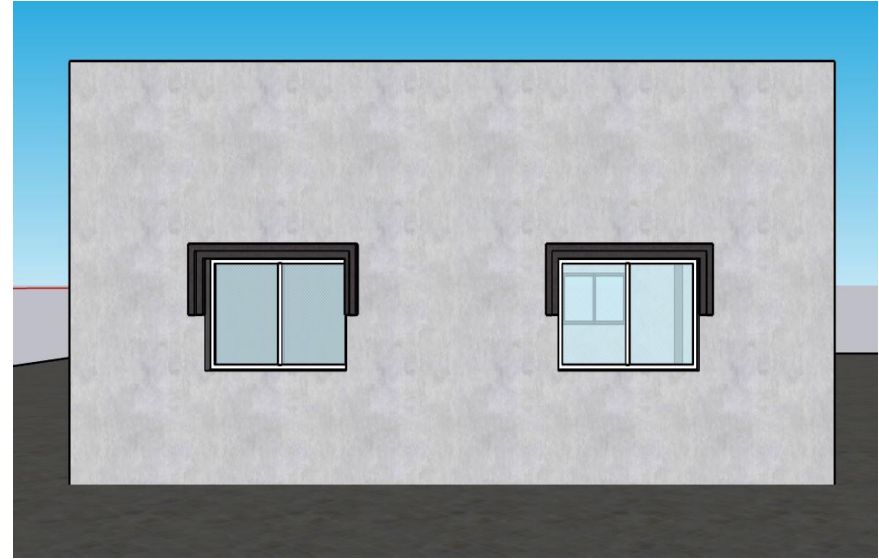
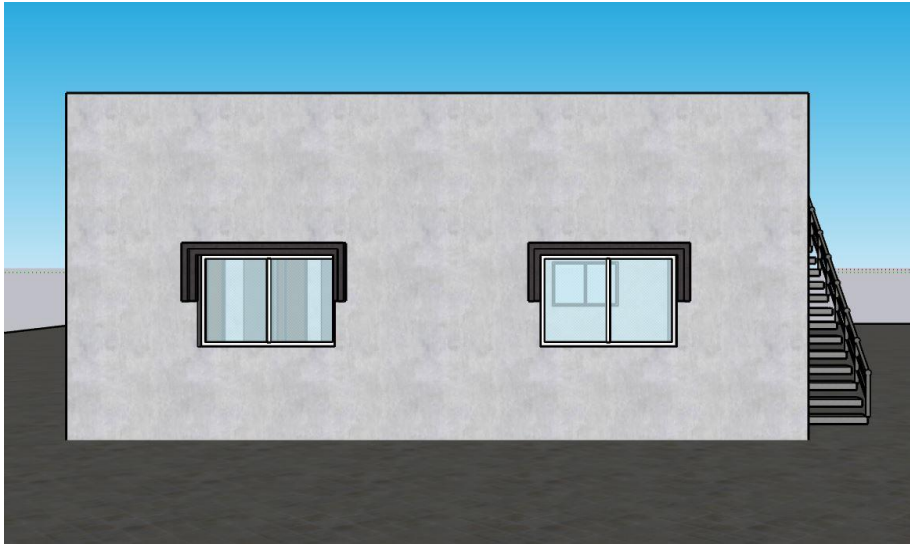

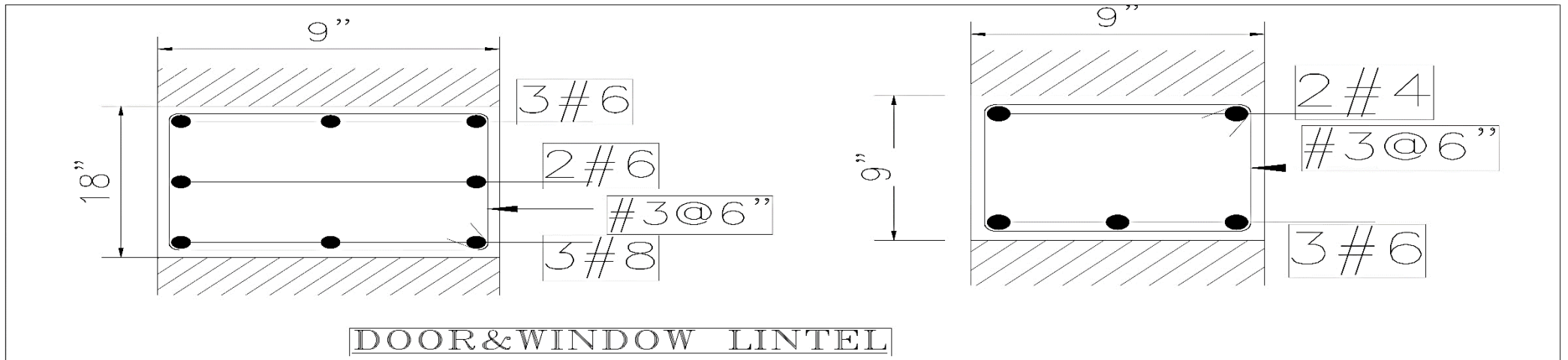

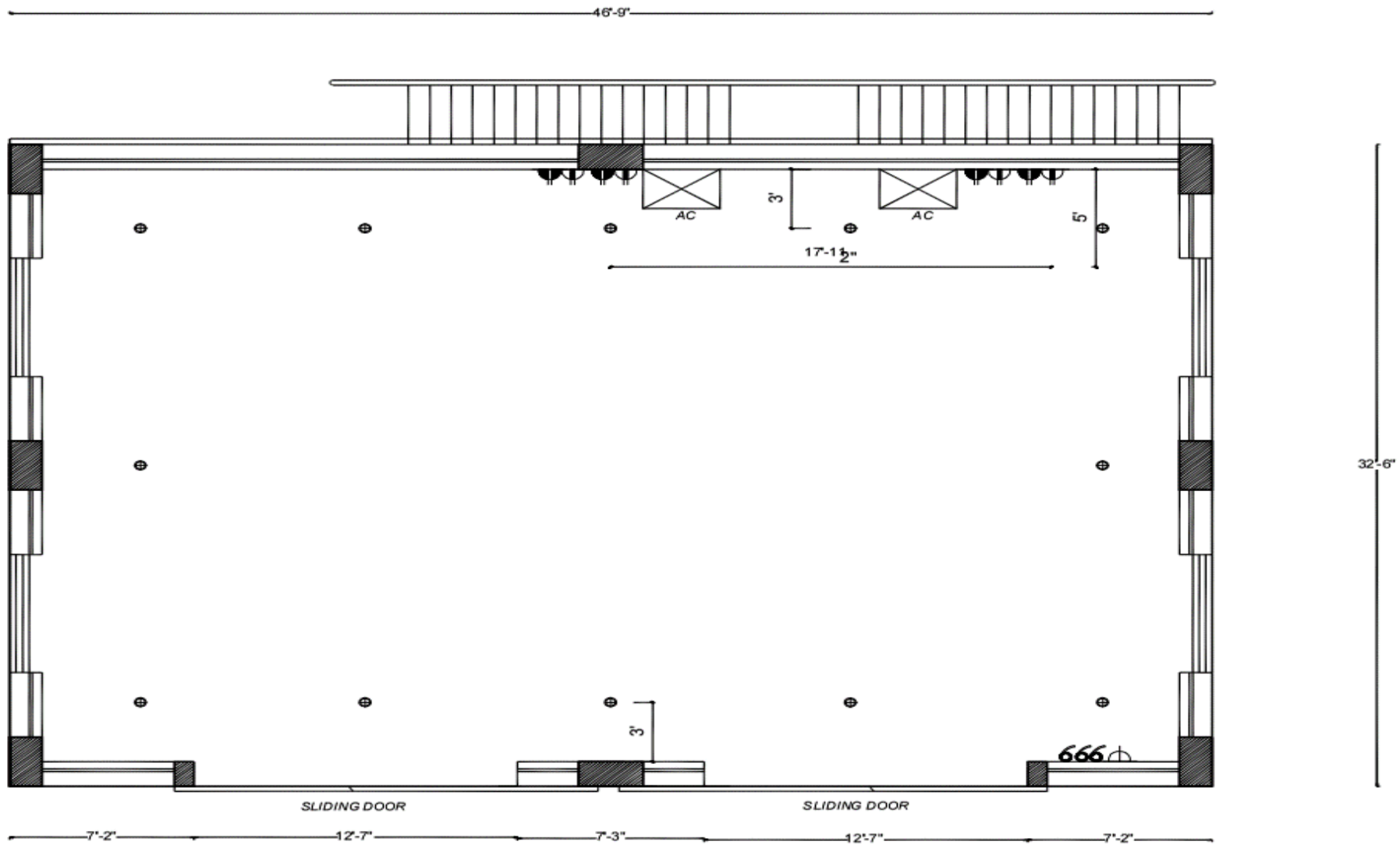

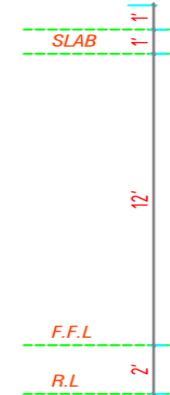
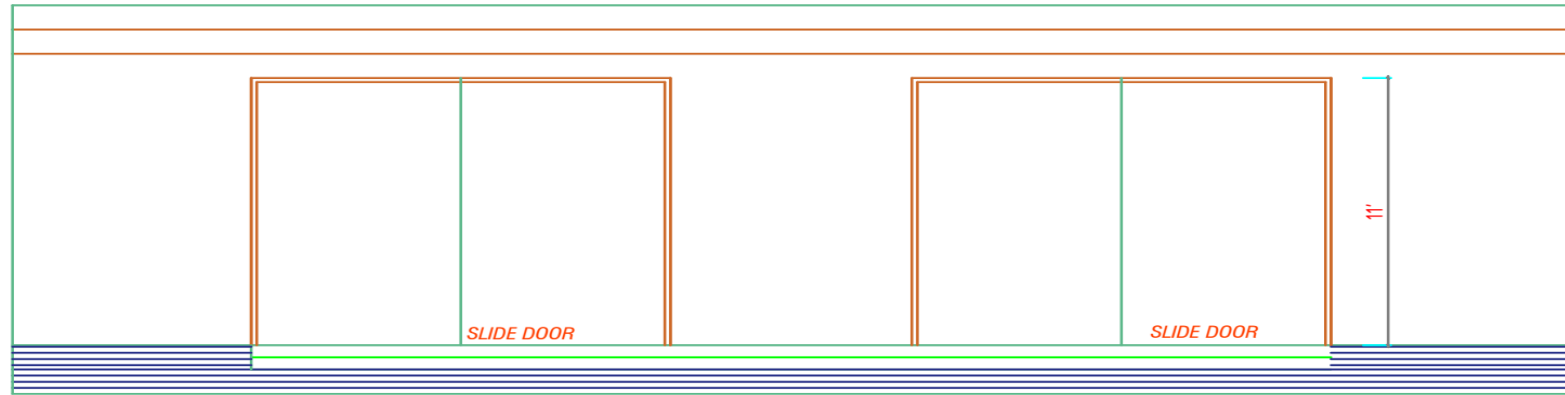

FRONT ELEVATION

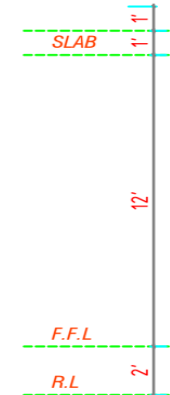
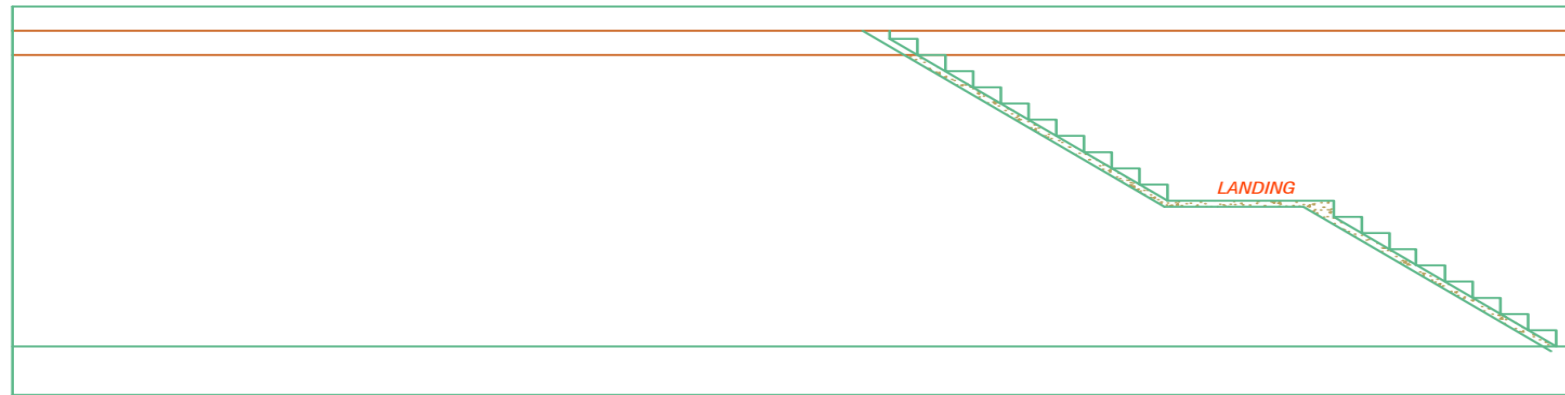

BACK ELEVATION

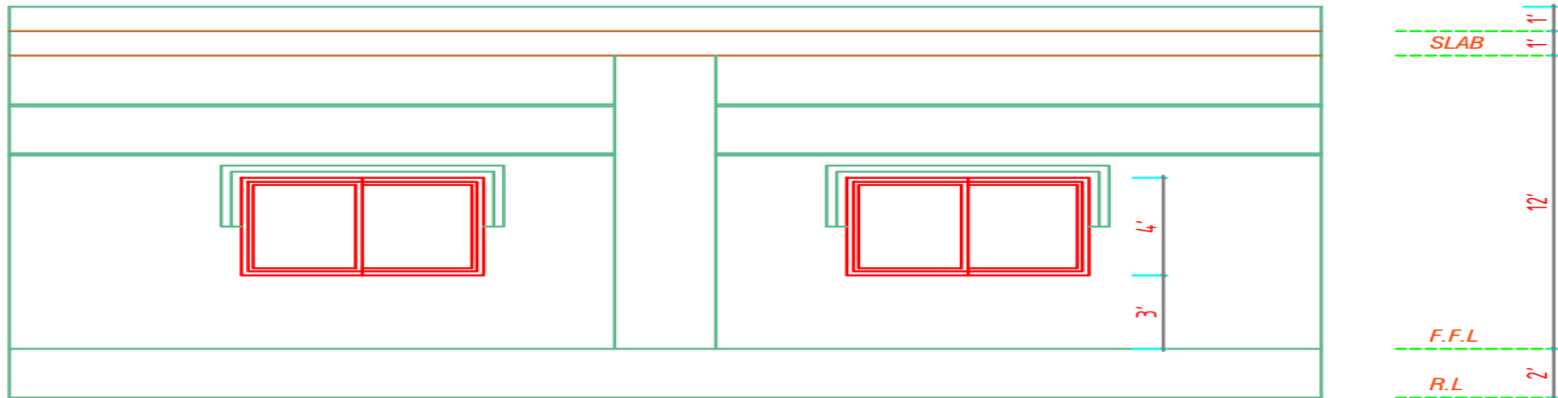

EAST SIDE ELEVATION

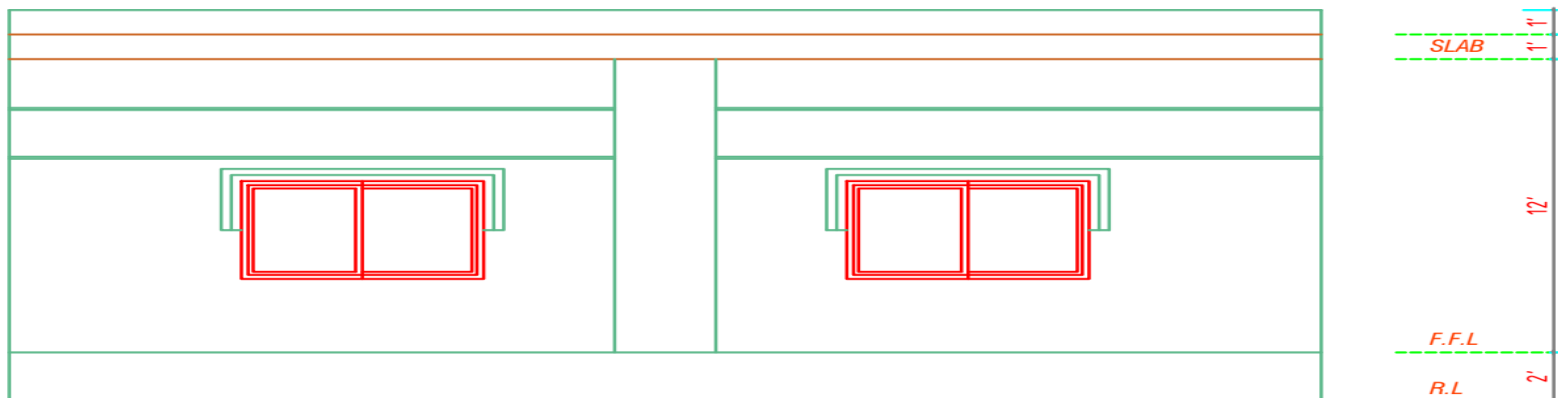

WAIST SIDE ELEVATION

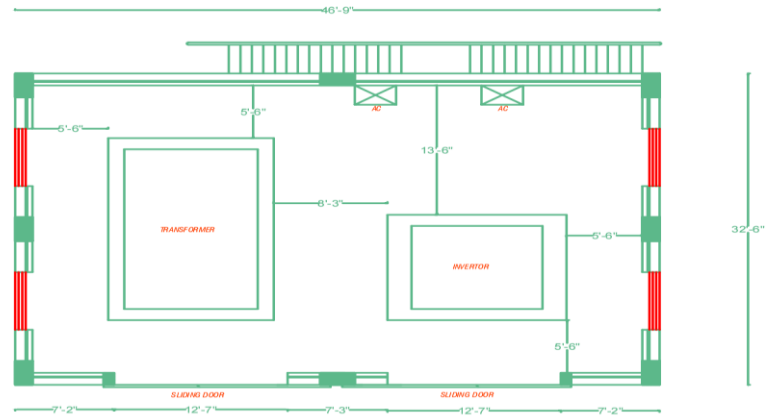

road

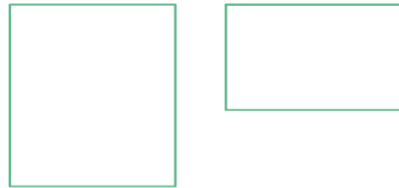

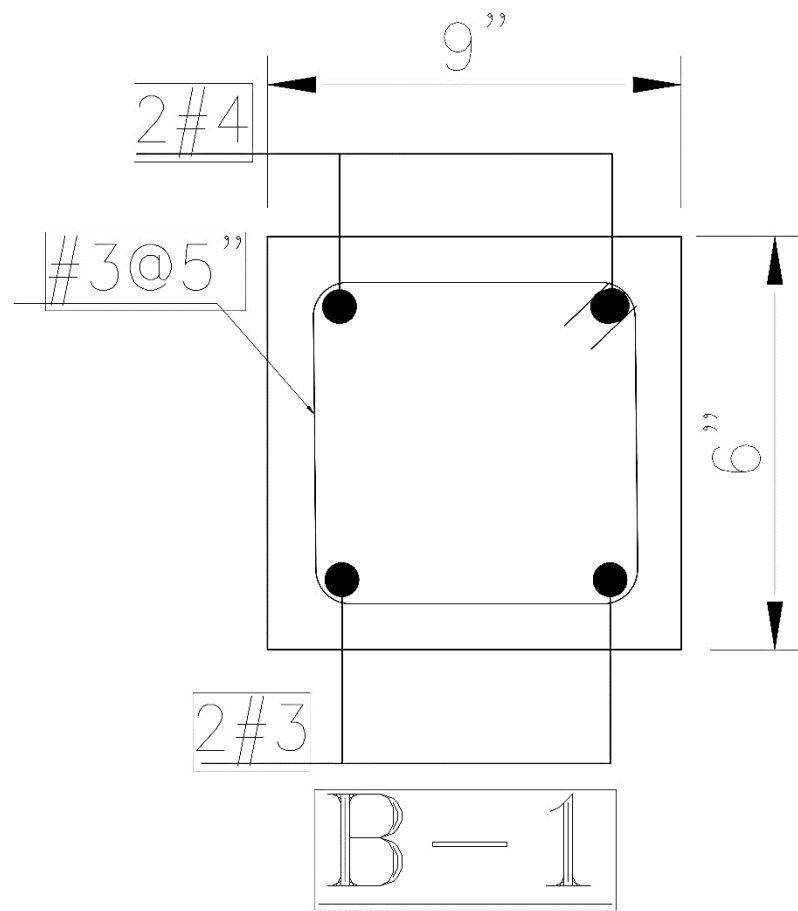

PERIPHERY BEAM

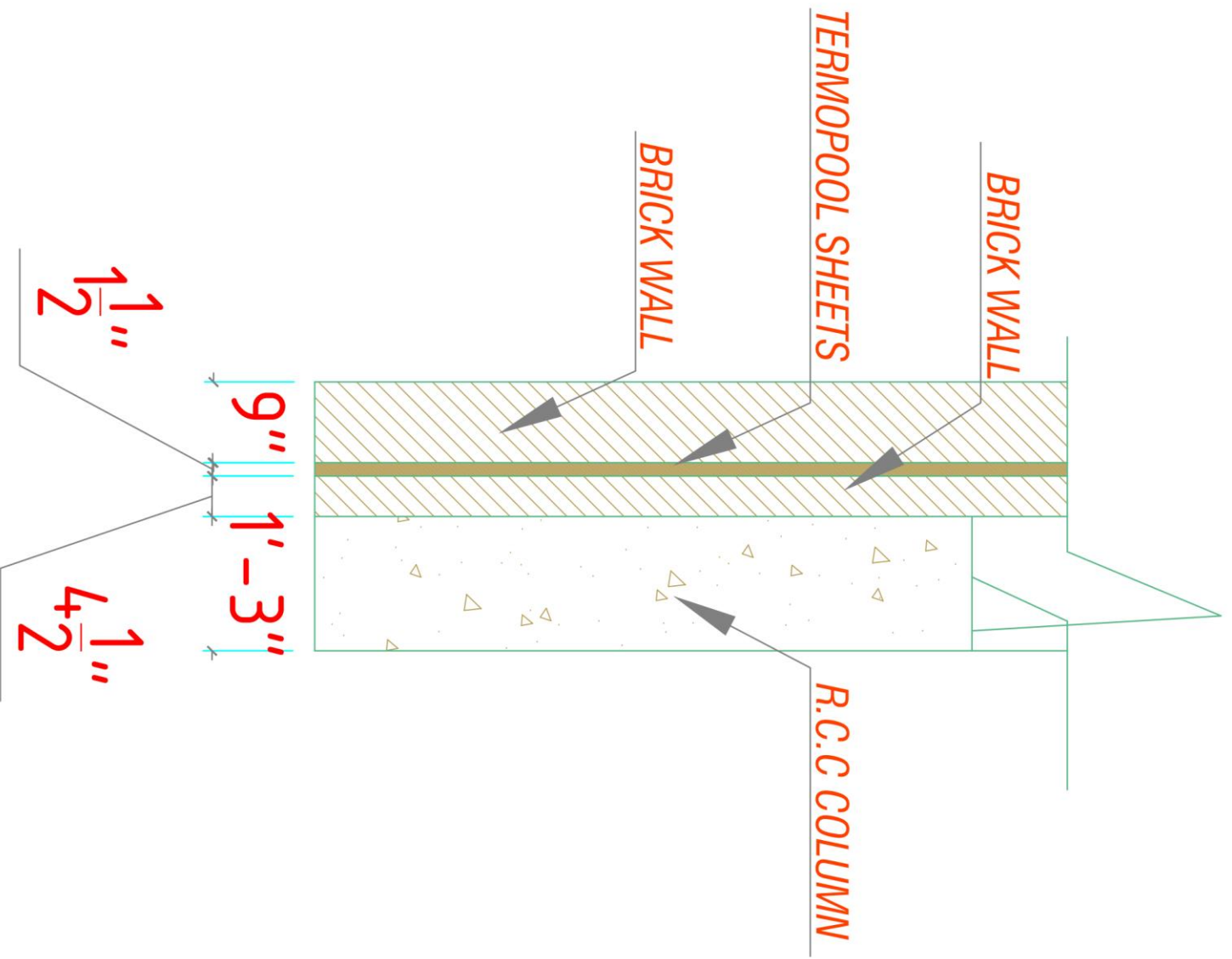

SECTION A-A

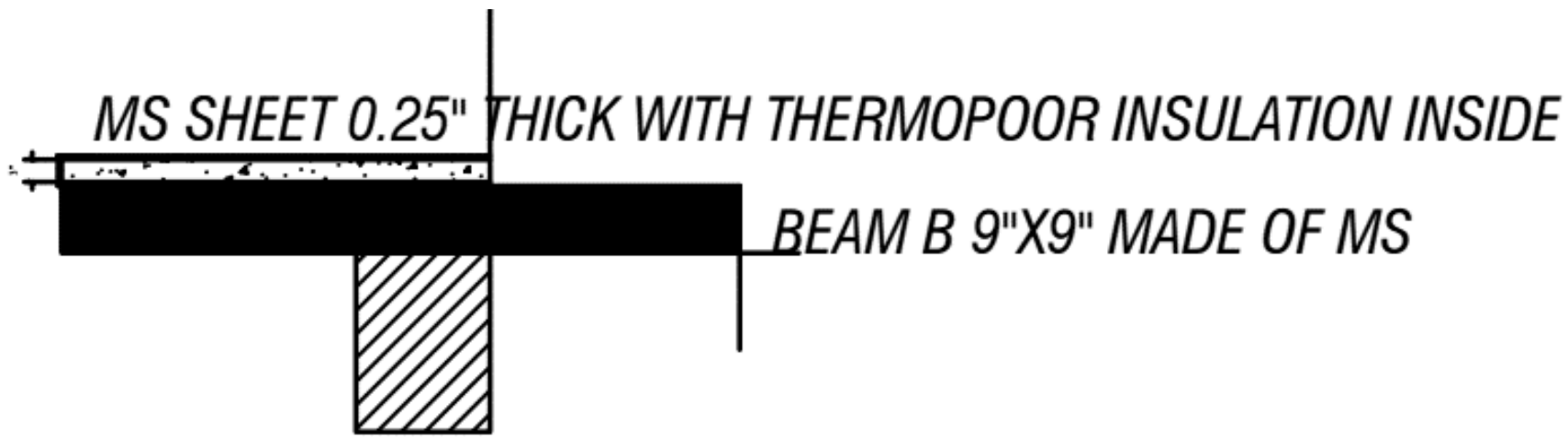

MS SHEET 0.25" THICK WITH THERMOPOOR INSULATION INSIDE

BEAM B 9"X9" MADE OF MS

MAIN BEAM 18"X24" MADE OF MS

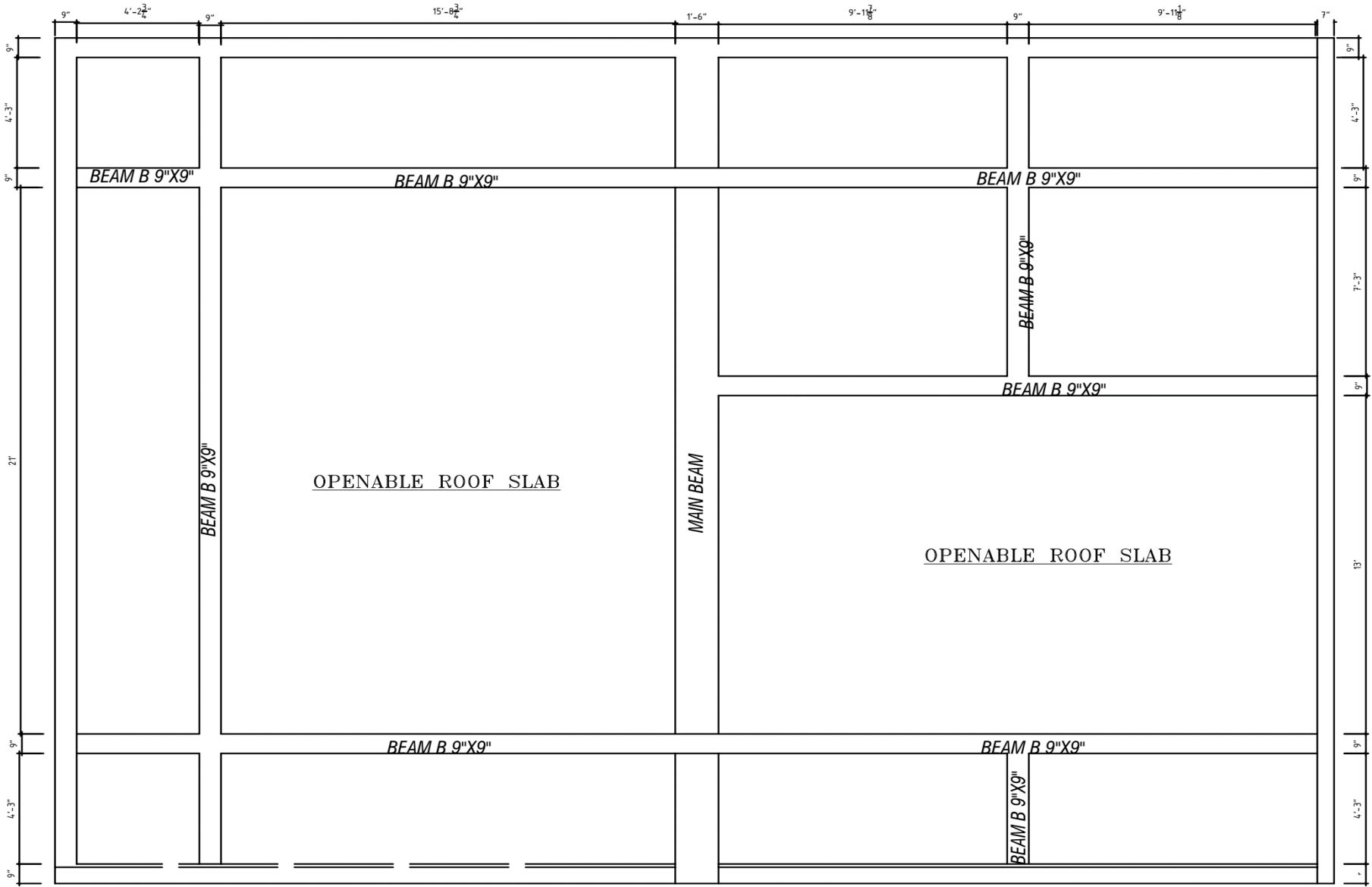

4"Ø RAIN WATER
PIPE DN TO
GROUND FLOOR

KHURRA
2' x 2'

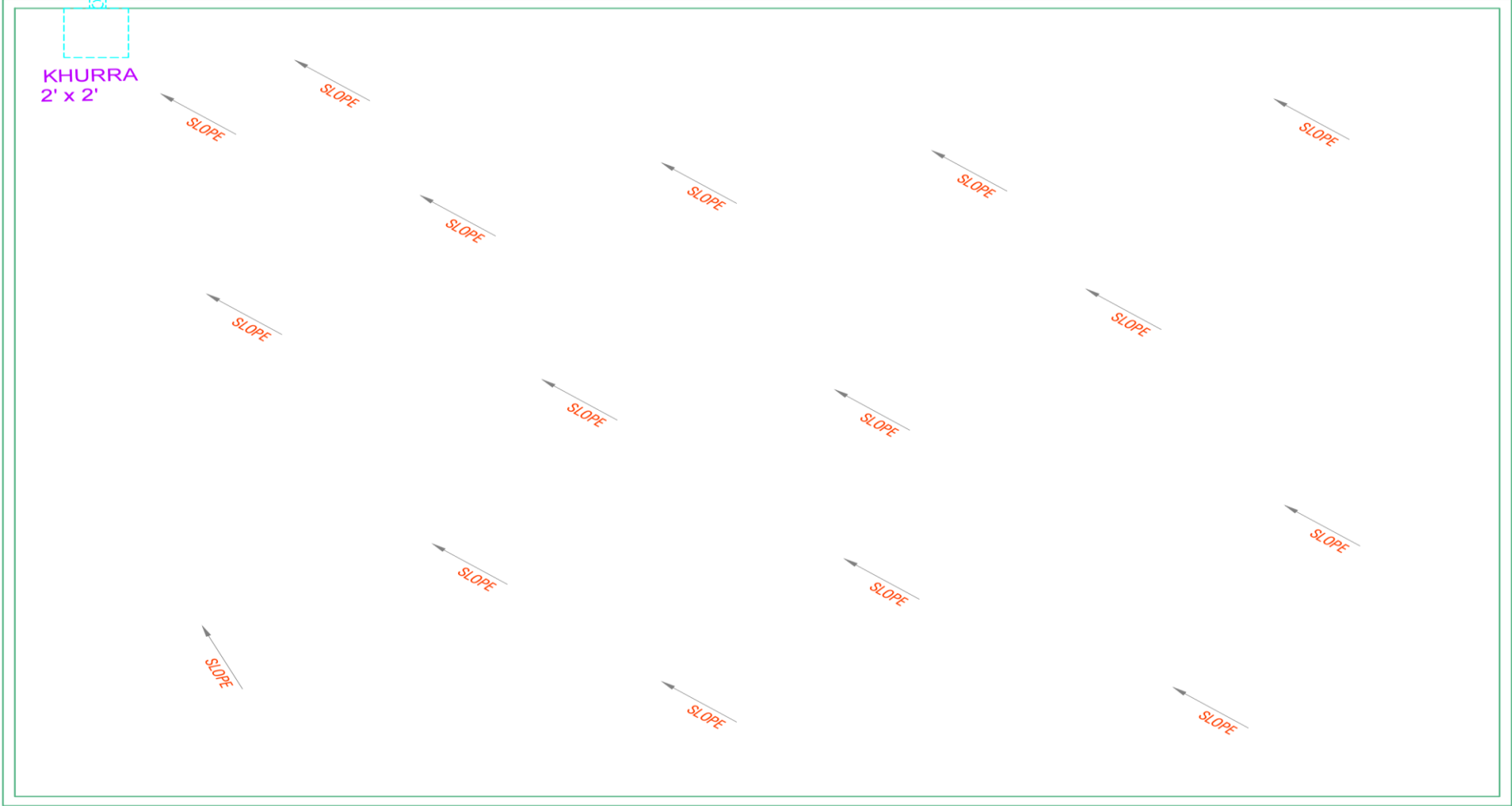

SCHEDULE OF FOOTING

SCHEDULE OF FOOTING							
MARK	SIZE		THICKNESS			REINFORCEMENT	
	X	Y	T	t	C	ALONG-X	ALONG-Y
F-1	5'-0"	5'-0"	21"	12"	4½"	#4@7"	#4@7"



